



JVC

ENGLISH

JVC

InteriArt

LT-30E45SJ

WIDE LCD PANEL TV

INSTRUCTIONS



50059704

1004MKH-VT-VT

Contents

Important Instruction	1
How to remove the stand	2
Important Information	3
TV Control Buttons and Terminals	4
Remote Control Buttons	6
Preparation	7
Safety Precautions	7
Before Switching On Your TV	9
Switching The TV ON/OFF	9
Operating The TV	10
Other Features	18
Teletext	21
Connect Peripheral Equipment	22
Antenna Connections	24
PC Input Typical Display Modes	25
PIP Combination Restrictions	25
Tips	26
Specifications	27

Important Instruction

For your own safety read following instruction carefully before attempting to connect this unit to the mains supply.

MAINS (AC) OPERATION

The wires in this mains lead are coloured in accordance with the following code :

BLUE-NEUTRAL

BROWN-LIVE

As the colours of the wires in the mains lead of this appliance may not correspond with the coloured markings identifying the terminals in your plug, proceed as follows:

The wire which is coloured blue must be connected to the terminal which is marked with the letter N or coloured black.

The wire which is coloured brown must be connected to the terminal which is marked with the letter L or coloured red.

No connection is to be made to the earth terminal of the plug.

If a 13 Amp (BS 1363) Plug is used a 5 Amp Fuse must be fitted, or if any other type of Plug is used a 5 Amp Fuse must be fitted, either in the Plug of Adaptor, or on the Distribution Board.

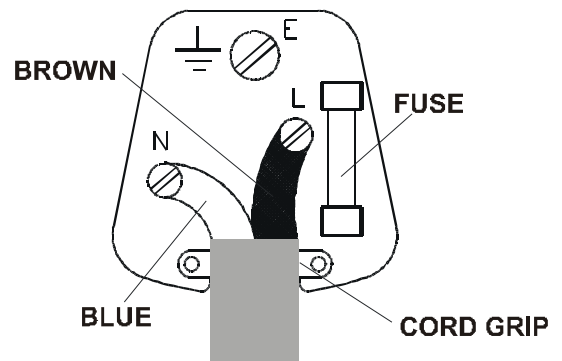

CAUTION

TO PREVENT ELECTRIC SHOCK DISCONNECT FROM THE MAINS BEFORE REMOVING COVER. NO USER SERVICEABLE PARTS INSIDE. REFER SERVICING TO QUALIFIED SERVICE PERSONNEL.

SAFETY PRECAUTION

THIS EQUIPMENT MUST BE DISCONNECTED FROM THE MAINS WHEN NOT IN USE. DO NOT ALLOW THIS UNIT TO BE EXPOSED TO RAIN OR MOISTURE.

WARNING

- Do not allow children to hang from the TV, place their elbows on the TV or lean against the TV. Doing so may cause the TV to fall over and lead to injuries.

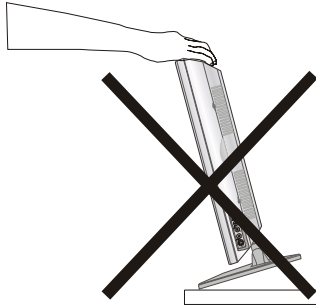

CAUTION:

- The TV screen may be damaged if the TV is carried as shown in the diagram below. The TV should always be carried by two people.



How to remove the stand

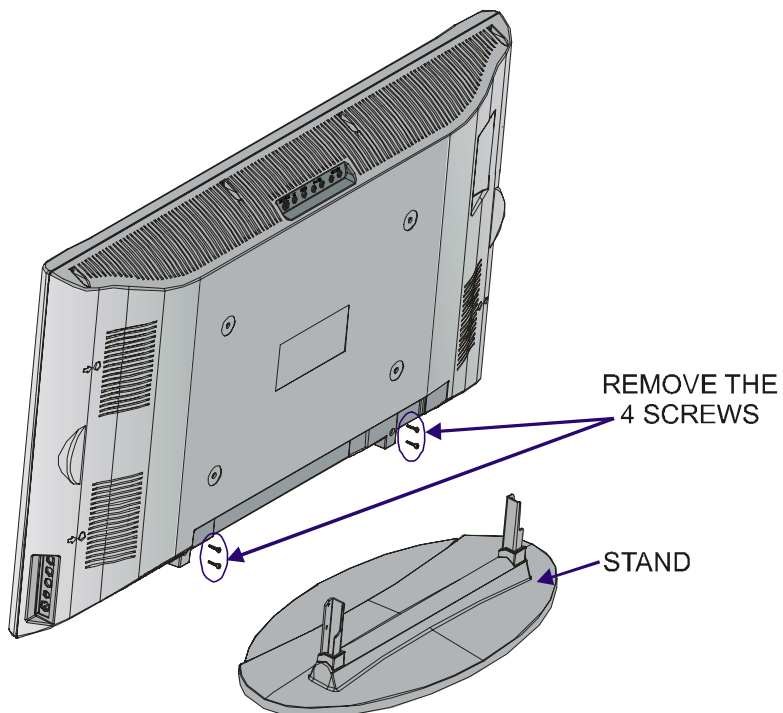

Important Information

Please take note

EXCLUSION CLAUSE

JVC shall under no circumstances be liable for loss and/or damage to the product caused by:

- fire;
- earthquake;
- accidental damage;
- intentional misuse of the product;
- use of the product in improper conditions;
- loss and/or damage caused to the product whilst in the possession of a third party;
- any damage or loss caused as a result of the owner's failure and/or neglect to follow the instructions set out in the owner's manual;
- any loss or damage caused directly as a result of misuse or malfunction of the product when used simultaneously with associated equipment;

Furthermore, under no circumstances shall JVC be liable for any consequential loss and/or damage including but not limited to the following, loss of profit, interruption of business, the loss of recorded data whether caused during normal operation or misuse of the product.

WARNING! NEVER LEAVE A STATIONARY IMAGE ON THE SCREEN

If stationary images generated by TELETEXT, CHANNEL IDENTIFICATION LOGOS, COMPUTER DISPLAYS, VIDEO GAMES, ON SCREEN MENUS, etc. are left on the TV screen for any length of time, they could become permanently ingrained.

If you use your television to display completely still images, or moving pictures which have a permanent still image superimposed e.g. broadcast network logos, it is always advisable to reduce BOTH the brightness and contrast settings.

Care and disposal

Cleaning the screen and cabinet...

Turn off the power, clean the screen and cabinet with a soft, dry cloth. We recommend that you do not use any proprietary polishes or solvents on the screen or cabinet as this may cause damage.

Disposal...

When the set reaches the end of its useful life please dispose of it in accordance with Local Government Regulations or at a recycling centre.

TV Control Buttons and Terminals

FRONT VIEW

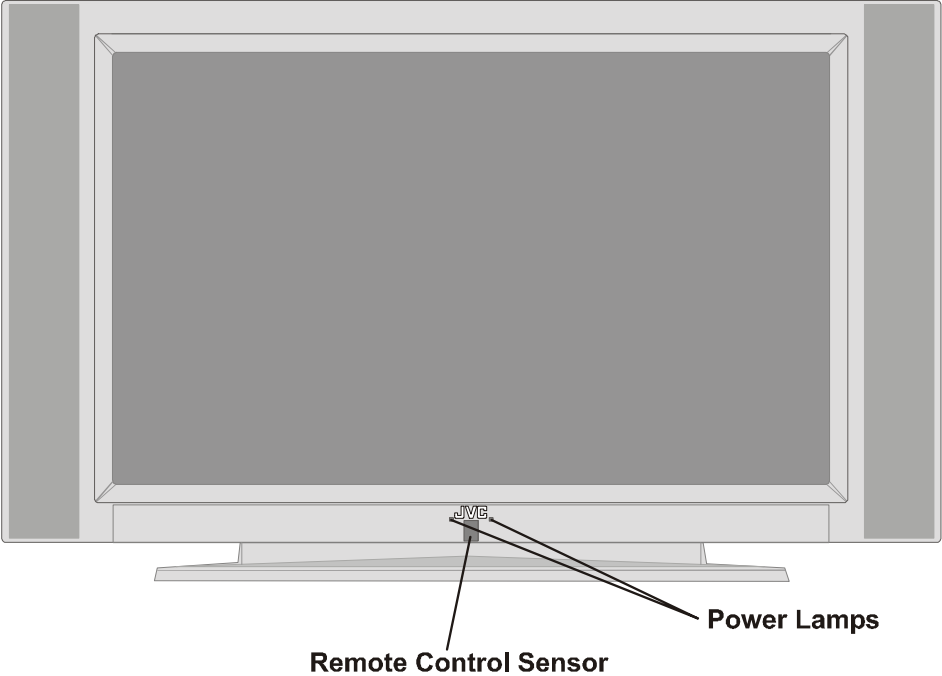

REAR VIEW

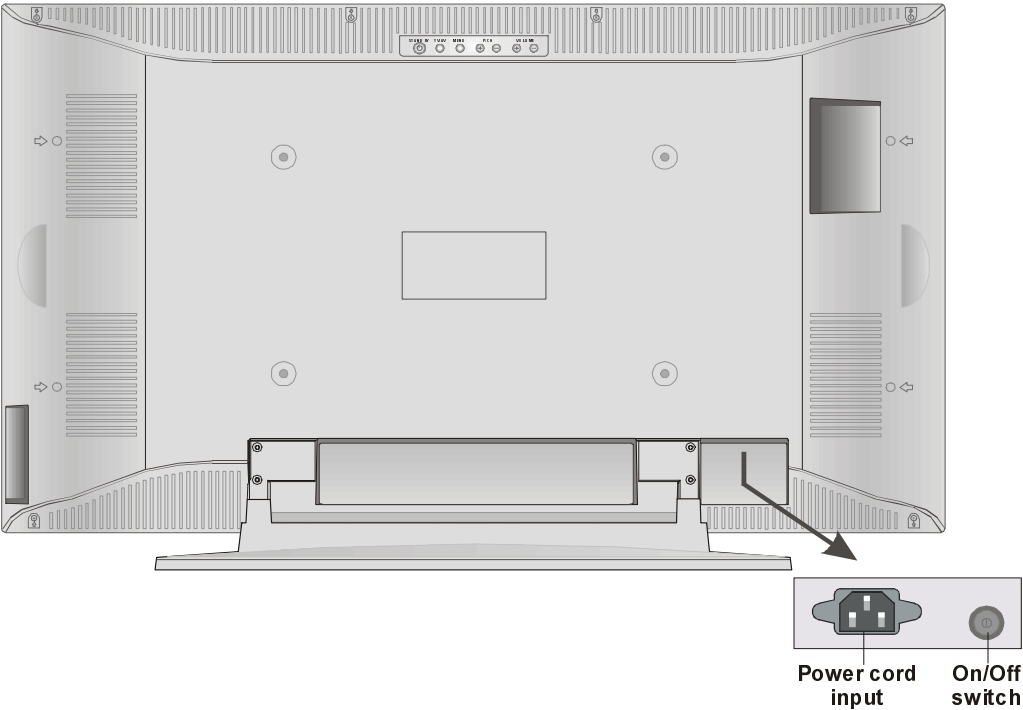

- Ⓐ Headphone
- Ⓑ Audio Input (Left, Right)
- Ⓒ Video Input
- Ⓓ S-VHS Input
- Ⓔ STAND BY button
- Ⓕ TV/AV button
- Ⓖ MENU button
- Ⓗ Program Up, Program Down buttons
- Ⓘ Volume Up, Volume Down buttons
- Ⓙ Power cord input
- Ⓚ On/Off switch
- Ⓛ Antenna
- Ⓜ Audio Line Out L, R
- Ⓝ Scart 1
- Ⓞ Scart 2
- Ⓟ Audio In (for PC)
- Ⓡ PC Input

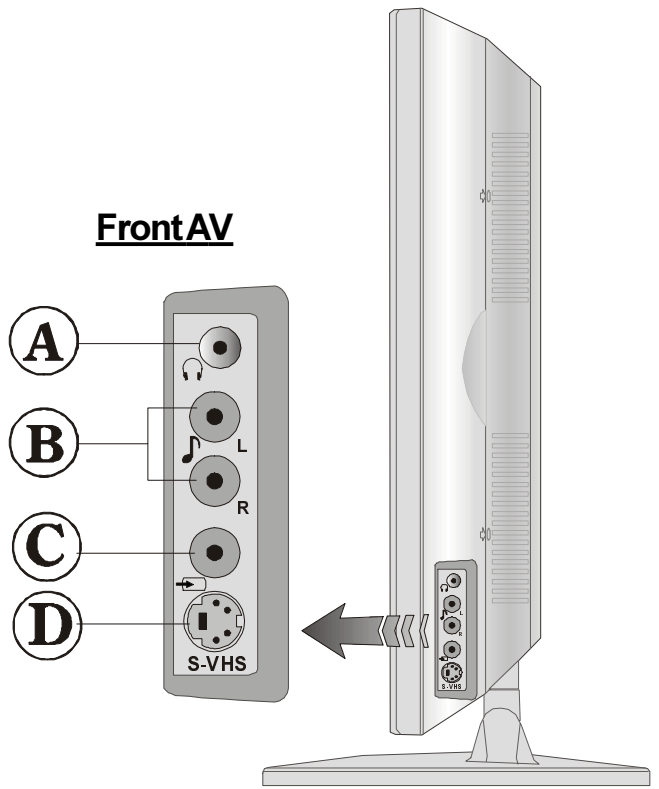

TV Control Buttons

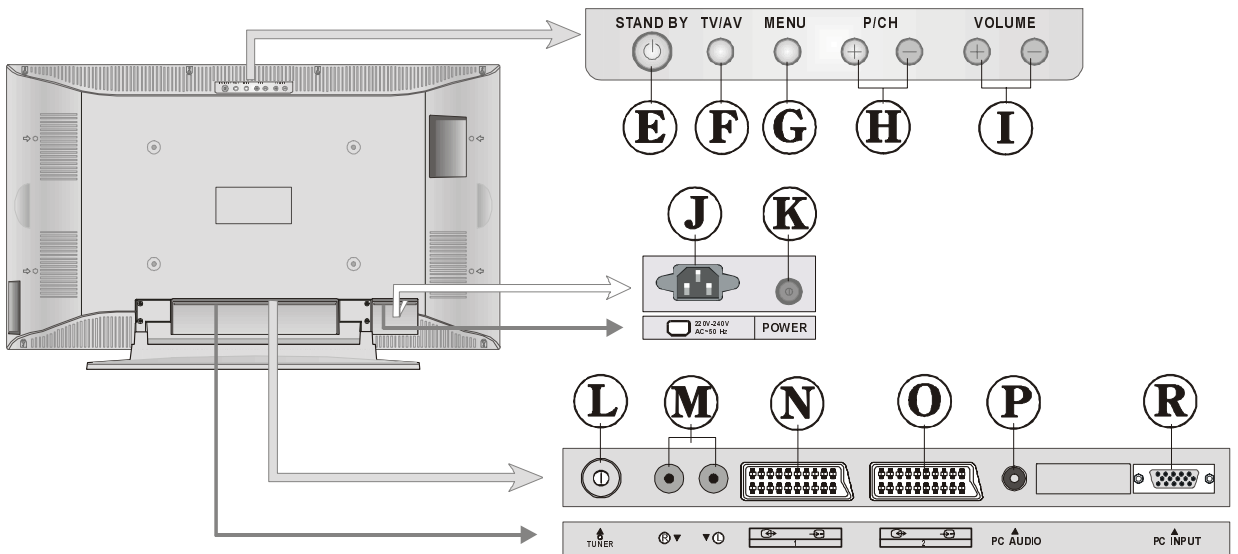

Remote Control Buttons

- ① = (Stand By) button
- ② TV / VCR / DVD Switch
- ③ Number buttons
- ④ **AV** button (Tuner, Scart 1, Scart 1 RGB, Scart 2, Scart 2 RGB, PC, FAV, SVideo)
- ⑤ **BLUE / PICTURE** Mode button
- ⑥ **YELLOW** / Sleep Timer button
- ⑦ **MENU** button
- ⑧ = Cursor Up button
- ⑨ OK button
- ⑩ = Cursor Right button
- ⑪ **BACK** button
- ⑫ = Volume + / - buttons
- ⑬ Teletext / VCR / DVD Control buttons
- ⑭ PIP Control Buttons
- ⑮ P \wedge / \vee buttons
- ⑯ = Cursor Down button
- ⑰ = Teletext Button
- ⑱ I/II = Stereo / Bilingual button
- ⑲ **GREEN** / Hyper Sound On/Off button
- ⑲ **RED / ZOOM** Mode button
- ⑳ = Information Button
- ㉓ = Mute button

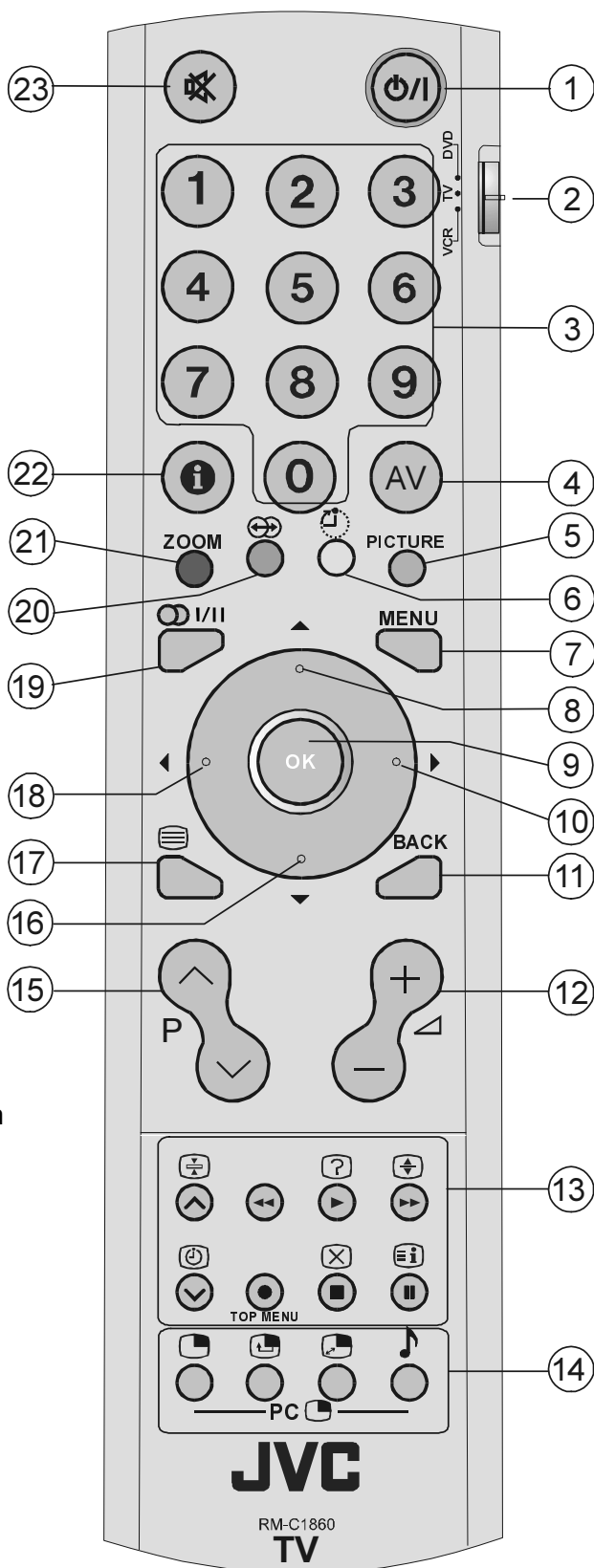

Preparation

For ventilation, leave a space of at least 10 cm free all around the set. To prevent any fault and unsafe situations, please do not place any objects on top of the set.

Use this apparatus in tropical and/or moderate climates.

Features

- It is a remote controlled color television.
- 100 programmes from VHF, UHF bands or cable channels can be preset.
- It can tune cable channels.
- Controlling the TV is very easy by its menu driven system.
- It has 2 Euroconnector sockets for external devices (such as video, video games, audio set, etc.)
- Stereo sound system (German+Nicam).
- Full function Teletext .
Fastext (10 Pages), TOP text.
- It is possible to connect headphone.
- Direct channel access.
- A.P.S. (Automatic Programming System).
- All programmes can be named.
- Sleep timer.
- Automatic sound mute when no transmission.
- Auto, Full, 16:9 Zoom, 16:9 Zoom Subtitle, Regular, Panoramic, 14:9 Zoom modes. Auto switch WSS (Wide Screen Signaling).
- NTSC Playback.
- Front SVHS is available.
- Front AV in is available.
- It has VGA connector for external devices such as computer.
- It has PIP functions.
- TV Picture in PC
- When no valid signal is detected, after 5 minutes the TV switches itself automatically to stand-by mode.
- PC input (Support Up to WXGA 1280 x 768)
- 1 SVHS Input and 1 RCA AV Input are available.

- Stereo PC Audio Input
- 4H Comb Filter
- Audio Line Out

Panel Features

- High resolution, 30-inch TFT LCD display.
- WXGA resolution (1280 x 768)
- Contrast ratio (600:1 typical)
- Brightness (typical) 550 cd/m²
- Response time (typical) 25 msec.
- Viewing angle (typical) 170° (horizontal) and 170° (vertical).
- Display color 16.7 Million.

Safety Precautions

1. Power Source

The receiver should be operated only from a **220 - 240 V AC, 50 Hz.** outlet. Ensure you select the correct voltage setting for your convenience.

2. Power Cord

The power supply cord should be placed so that it is not likely to be walked on or pinched by items placed upon them or against it. Pay particular attention to cord where it enters the plug, power outlet, and the point where it exits from the receiver.

3. Moisture and Water

Do not use this equipment in a humid and damp place (avoid the bathroom, the sink in the kitchen, and near the washing machine). Do not expose this equipment to rain or water, as this may be dangerous and do not place objects filled with liquids on top. Avoid from dripping or splashing.

4. Cleaning

Before cleaning, unplug the receiver from the main supply, outlet. Do not use liquid or aerosol cleaners. Use soft and dry cloth.

5. Ventilation

The slots and openings on the receiver are intended for ventilation and to ensure reliable operation. To prevent overheating, these open-

ings must not be blocked or covered in any way.

6. Lightning

In case of storm and lightning or when going on holiday, disconnect the power cord from the wall outlet.

7. Replacement Part

When replacement parts are required, be sure the service technician has used replacement parts which are specified by the manufacturer or have the same specifications as the original one. Unauthorised substitutions may result in fire, electrical shock, or other hazards.

8. Servicing

Please refer all servicing to qualified personnel. Do not remove cover as this may result in electric shock.

9. Naked Flame Sources

Do not place naked flame sources on the apparatus.

WARNING: When the device is not in use for a long time, disconnect from power.

Instructions for waste disposal:

- Packaging and packaging aids are recyclable and should principally be recycled. Packaging materials, such as foil bag, must be kept away from children.
- Battery, including those which is heavy metal-free, should not be disposed of with household waste. Please dispose of used battery in an environmentally sound manner. Find out about the legal regulations which apply in your area.
- Cold cathode fluorescent lamp in LCD PANEL contains a small amount of mercury, please follow local ordinates or regulations for disposal.

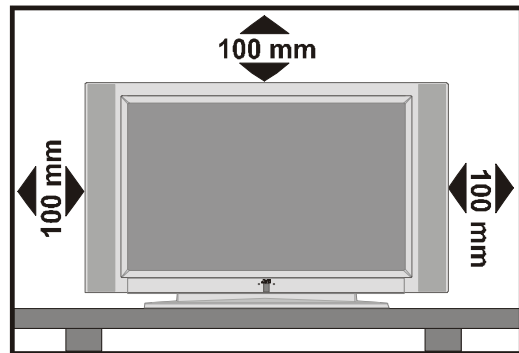
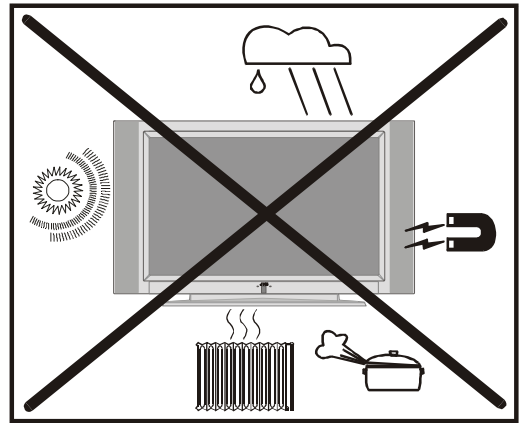

"The LCD panel is very high technology product with about a million thin film transistors, giving you fine picture details. Occasionally, a few non-active pixels may appear on the screen as a fixed point of blue, green or red. Please note that this does not affect the performance of your product."

"DO NOT LEAVE YOUR TV AT STAND-BY OR OPERATING WHEN YOU LEAVE YOUR HOUSE"

Before Switching On Your TV

Power Connection

IMPORTANT: The TV set is designed to operate on **220 - 240 V AC, 50 Hz.**

- After unpacking, allow the TV set to reach the ambient room temperature before you connect the set to the mains.

Connections To The RF Input Socket

- Connect the aerial or cable TV plug to the RF input socket located at the back of the TV and connect the cable plug coming out from the TV out socket located at the devices (VCR, DVB etc.) to this socket as well.

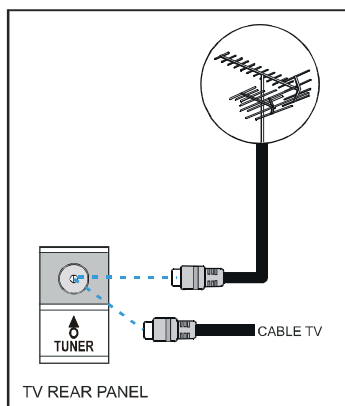

How To Connect Other Devices

IMPORTANT: Switch off the TV before connecting any external device.

Sockets for external connections are at the back and side of the TV. For connection of other devices via Euroconnector refer to the manuals of the related devices.

Inserting Batteries In The Remote Control Handset

- Place the batteries in the right directions as seen below.
- Remove the battery cover located on the back of the handset by gently pulling upwards from the indicated part.
- Insert two **AA/R6** dry cell or equivalent type of batteries inside.
- Replace the battery cover.

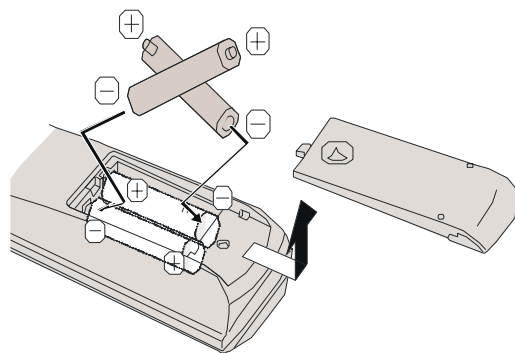

NOTE: Remove batteries from remote control handset when it is not to be used for a long period. Otherwise it can be damaged due to any leakage of batteries.

Switching The TV ON/OFF

To switch the TV on:

Your TV will switch on in two steps:

- 1- Connect the power supply cord to the system. Press On/Off switch at the rear of the TV. Then the TV switches itself to stand-by mode and the power lamp becomes red located on the front of the TV.
- 2- To switch on the TV from stand-by mode either:

Press a digit button on the remote control so that a programme number is selected, or,

Press "**⏻ / I**", "**-P/CH**" or "**P/CH+**" button at the top of the TV or press "**P∨**" or "**P∧**" button on the remote control, so that last switched off programme is selected.

By either ways the TV will switch on and the power lamp becomes green.

To switch the TV off:

- Press the "stand-by" button on the remote control, so the TV will switch to stand-by mode and the power lamp will become **RED**, or,

Press the "**⏻ / I**" button located on the top of the TV, so the TV will switch off and the power lamp will become **RED**.

To switch the TV off completely press On/Off switch at the rear of the TV and remove the mains plug from the socket.

Operating The TV

You can operate your TV both using the remote control handset and onset buttons.

Initial APS (Automatic Programming System)

The following menu will be displayed on the screen when you turn on your TV for the first time. APS, searches and sorts all channels and stores them automatically on your TV, according to the transmission of programme systems in your area.

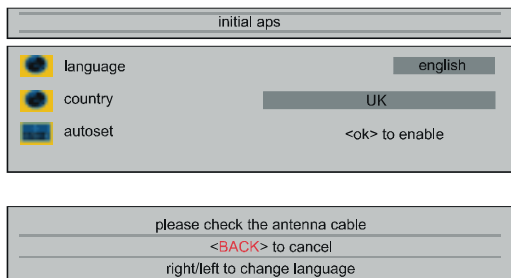

To cancel APS before starting, press **"BACK"** button.

First of all choose **language** and **country** by using **"▲" / "▼"** and **"◀" / "▶"** buttons. This will effect the sort process in APS. To start aps select **autoset**, by using **"▲" / "▼"** buttons and press **"◀" / "▶"** or **"OK"** button. While APS is running, no picture appears.



After APS is finalized, the programme table will be appeared on the screen. In the programme table you will see the programme numbers and names assigned to the programmes.

If you do not accept the locations and / or the programme names of programmes, you can change them in aps submenu in the settings menu. (See [page 17](#) for Program table explanation.)

Operating with the buttons on the TV set

Volume setting and programme selection can be made by using the buttons at the control panel on the top of the TV.

Volume Setting

Press **"VOLUME -"** button to decrease volume or **"VOLUME +"** button to increase volume, so a volume level scale (slider) will be displayed at the middle of the bottom on the screen.



Programme Selecting

Press **"P/CH+"** button to select the next programme or **"PCH-"** button to select the previous programme.

"P/CH+ / PCH-" and **"VOLUME + / VOLUME -"** buttons on the TV are used as navigation buttons in menu.

Entering The Menu

Press **"MENU"** button at the control panel on the top of the TV to enter the menu.

"P/CH+ / PCH-" and **"VOLUME + / VOLUME -"** buttons at the control panel on the top of the TV work as direction buttons in the menu.

EXT Mode

Press **"TV/AV"** button at the control panel on the top of the TV to switch your TV to EXT mode (See **EXT Modes** in [page 20](#)).

Operating With Remote Control

The remote control handset of your TV is designed to control all the functions of the model you selected. The functions will be described in accordance with the menu system of your TV.

Functions of the menu system are described in Menu System section.

Volume Setting

Press **"▲ +"** button to increase volume. Press **"- ▼"** button to decrease volume. A volume level bar will be displayed at the middle of the bottom on the screen.

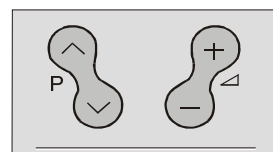

Programme Selecting (Previous or next programme)

- Press “**P**∨” button to select the previous programme.
- Press “**P**∧” button to select the next programme.

Programme Selecting (direct access):

Press digit buttons on the remote control handset to select programmes between 0 and 9. TV will switch to the selected program after a short delay.

- For a two digit program number enter the second digit after pressing the first digit within 2 seconds.

Menu System

Your TV has been designed with a menu system to provide an easy manipulation of a multifunction system. Press the “**MENU**” button to enter the menu.

Press “◀ / ▶” button to select a menu title and then “▲ / ▼” button to select a menu item and “◀ / ▶” or “**OK**” button to enter the submenu. Press “**MENU**” button to return to the previous menu. Press “**BACK**” button to exit from the menu.

layout menu

By pressing “◀ / ▶” button, select the first icon. Layout menu appears on the screen.

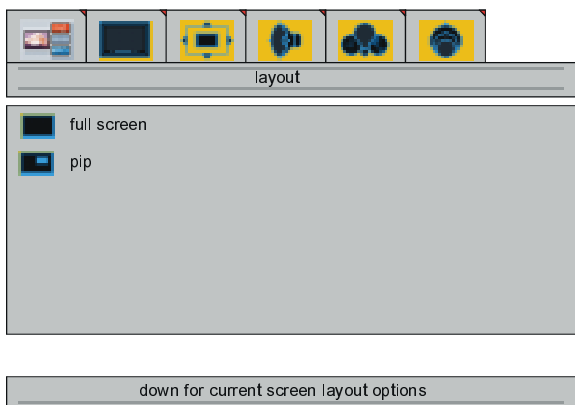

full screen

By pressing “▲ / ▼” button, select **full screen**. “<ok> activates one window layout” is seen on the screen. Press “▶” or “**OK**” but-

ton. One programme is displayed on the whole screen at this option.

pip

By pressing “▲ / ▼” button, select **pip**. “<ok> activates pip window layout” is seen on the screen. Press “▶” or “**OK**” button. The first programme can be watched on the background. The second programme is seen at the pip window.

PIP picture is displayed on the screen also with “◻” button.

Programme in the PIP window is increased / decreased by “**P**∨ / **P**∧”, digit buttons or AV button when PIP window is selected. PIP window is removed from the screen by “◻” button.

picture menu

By pressing “◀ / ▶” button, select the second icon. Picture menu appears on the screen.

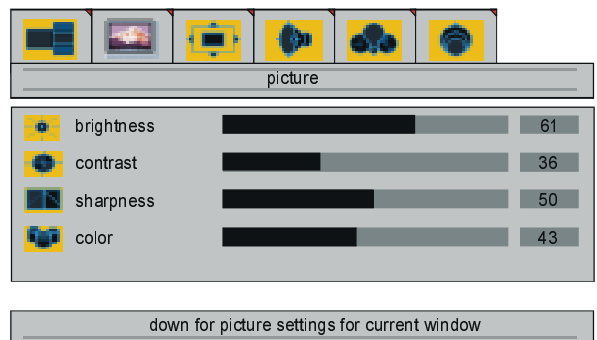

brightness

By pressing “▲ / ▼” button, select **brightness**. “right/left to adjust brightness” is seen on the screen. Press “▶” button to increase brightness. Press “◀” button to decrease brightness. Brightness level can be adjusted between 0 and 100.

contrast

By pressing “▲ / ▼” button, select **contrast**. “right/left to adjust contrast” is seen on the screen. Press “▶” button to increase contrast. Press “◀” button to decrease contrast. Contrast level can be adjusted between 0 and 100.

sharpness

By pressing “▲” / “▼” button, select **sharpness**. “right/left to change sharpness” is seen on the screen. Press “▶” button to increase sharpness. Press “◀” button to decrease sharpness. Sharpness level can be adjusted between 0 and 8.

color

By pressing “▲” / “▼” button, select **color**. “right/left to adjust color” is seen on the screen. Press “▶” button to increase color. Press “◀” button to decrease color. Color level can be adjusted between 0 and 100.

tint

This item is displayed in picture menu when TV is in AV mode and at NTSC signal. By pressing “▲” / “▼” button, select **tint**. “right/left to adjust tint” is seen on the screen. Press “▶” button to increase tint. Press “◀” button to decrease tint. Tint level can be adjusted between 0 and 100.



When TV is in AV mode; picture menu items (brightness, contrast, sharpness and color) may require re-adjustment.

When PC is Connected To TV:

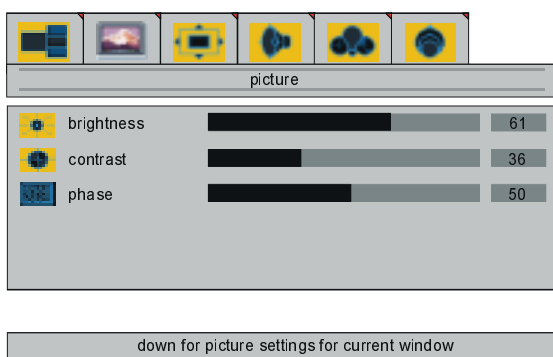

brightness

By pressing “▲” / “▼” button, select **brightness**. “right/left to adjust brightness” is seen on the screen. Press “▶” button to increase brightness. Press “◀” button to decrease brightness. Brightness level can be adjusted between 0 and 100.

contrast

By pressing “▲” / “▼” button, select **contrast**. “right/left to adjust contrast” is seen on the screen. Press “▶” button to increase contrast. Press “◀” button to decrease contrast. Contrast level can be adjusted between 0 and 100.

phase

By pressing “▲” / “▼” button, select **phase**. “right/left to adjust phase” is seen on the screen. Press “▶” button to increase phase. Press “◀” button to decrease phase. Phase level can be adjusted between 0 and 100.

window menu

By pressing “◀” / “▶” button, select the third icon. Window menu appears on the screen.

- If full screen option was selected at the layout menu, the window menu is seen as below.

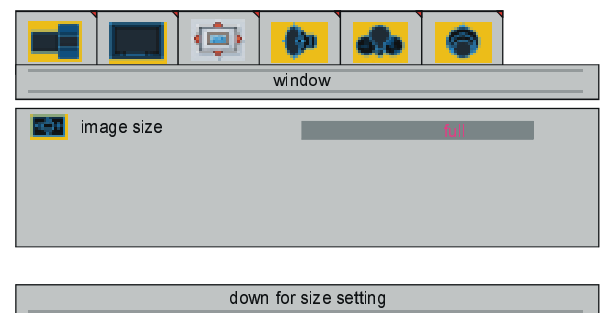

image size

By pressing “▲” / “▼” button, select **image size**. “right/left to change image size” is seen on the screen. By pressing “◀” / “▶” button, you can change image size to Auto, Full, 16:9 Zoom, 16:9 Zoom Subtitle, Regular, Panoramic, 14:9 Zoom modes.

You can enter image size directly by pressing “ZOOM” button.

- If pip option was selected, the window menu is seen as below.

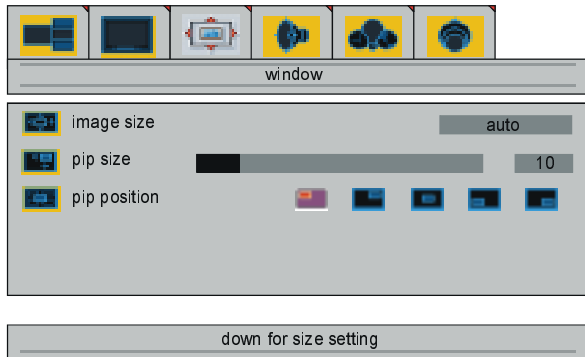

image size

By pressing “▲” / “▼” button, select **image size**. "right/left to change image size" is seen on the screen. By pressing “◀” / “▶” button, you can change image size to **full**, **regular** and **auto**.

You can enter image size directly by pressing “ZOOM” button. See [Page 20](#) for details.

pip size

By pressing “▲” / “▼” button, select **pip size**. "right/left to adjust PIP size" is seen on the screen. Press “▶” button to increase pip size.

Press “◀” button to decrease pip size. Pip size can be adjusted between 0 and 100.

When PIP is activated you can enter the pip size directly by pressing “” button.

pip position

By pressing “▲” / “▼” button, select **pip position**. "right/left to adjust PIP position" is seen on the screen. By pressing “◀” / “▶” button, you can change the pip position as left top, right top, middle, left bottom or right bottom (as seen on the menu above).

When PIP is activated you can change pip position directly by pressing "" button.

When PC Is Connected To TV

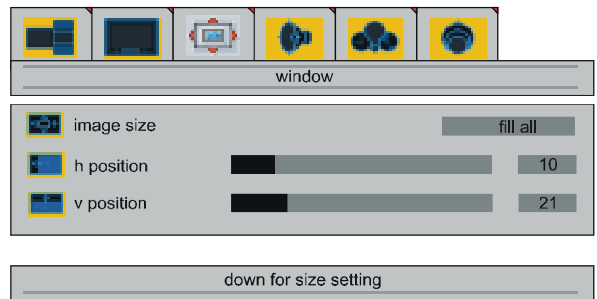

image size

By pressing “▲” / “▼” button, select **image size**. "right/left to change image size" is seen on the screen. By pressing “◀” / “▶” button, you can change image size to **Fill all**, **Fill 1:1** and **Fill aspect**.

h position

By pressing “▲” / “▼” button, select **h position**. "right/left to adjust h position" is seen on the screen. Press “▶” button to slide the screen to the left. Press “◀” button to slide screen to the right. **h position** can be adjusted between 0 and 100.

v position

By pressing “▲” / “▼” button, select **v position**. "right/left to adjust v position" is seen on the screen. Press “▶” button to slide the screen to up. Press “◀” button to slide screen to down. **v position** can be adjusted between 0 and 100.

audio menu

By pressing “◀” / “▶” button, select the fourth icon. Audio menu appears on the screen.

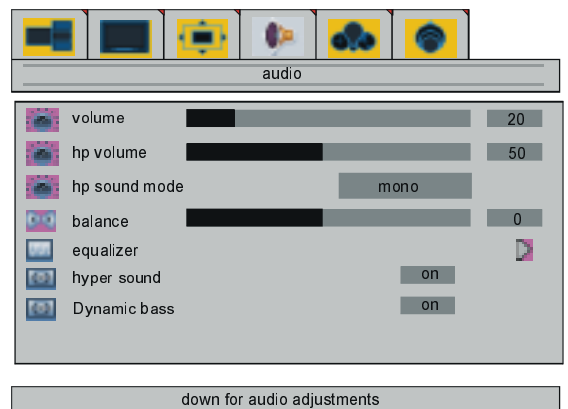

volume

By pressing “▲” / “▼” button, select **volume**. **"right/left to adjust volume"** is seen on the screen. Press “▶” button to increase volume level. Press “◀” button to decrease volume level. Volume level can be adjusted between 0 and 63.

hp volume

By pressing “▲” / “▼” button, select **hp volume**. **"right/left to adjust hp volume"** is seen on the screen. Press “▶” button to increase headphone volume level. Press “◀” button to decrease headphone volume level. Hp volume (headphone volume) level can be adjusted between 0 and 100.

hp sound mode

By pressing “▲” / “▼” button, select **hp sound mode**. **"right to adjust hp sound mode"** is seen on the screen. Press “◀” / “▶” button change hp sound mode.

Hp sound mode is used to identify sound mode of the headphone. hp sound mode can be set to **mono**, **stereo**, **dual a** or **dual b** according to the transmission.

balance

By pressing “▲” / “▼” button, select **balance**. **"right/left to adjust balance"** is seen on the screen. Press “▶” button to increase balance rightward. Press “◀” button to decrease balance leftward. Balance level can be adjusted between -50 and 50.

equalizer

By pressing “▲” / “▼” button, select **equalizer**. **"right/left for equalizer settings"** is seen on the screen. Press “◀” / “▶” or “OK” button to enter equalizer menu. In equalizer menu the sound mode can be changed to **user**, **flat**, **pop**, **rock**, **jazz** and **classic** by pressing “◀” / “▶” button. Equalizer menu settings can be changed only when **sound mode** is **user**. Select the desired frequency by “▲” / “▼” button and increase or decrease the frequency gain by pressing “◀” / “▶” button.

“MENU” button to exit the equalizer menu.

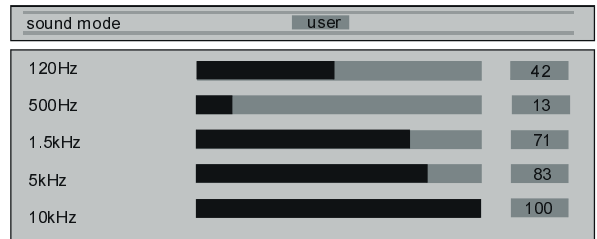

hyper sound

It is used to gain saloon effect to the sound.

By pressing “▲” / “▼” button, select **hyper sound**. **"right/left for wide sound off/stereo/mono"** is seen on the screen. By pressing “◀” / “▶” button set to hyper sound **on** to activate it or **off** to deactivate it.

dynamic bass

Dynamic Bass is used to increase bass effect of the TV set.

By pressing “▲” / “▼” button, select **dynamic bass**. **"right/left for dynamic bass on/off"** is seen on the screen. By pressing “◀” / “▶” button set to dynamic bass **on** to activate it or **off** to deactivate it.

options menu

By pressing “◀” / “▶” button, select the fifth icon. Options menu appears on the screen.

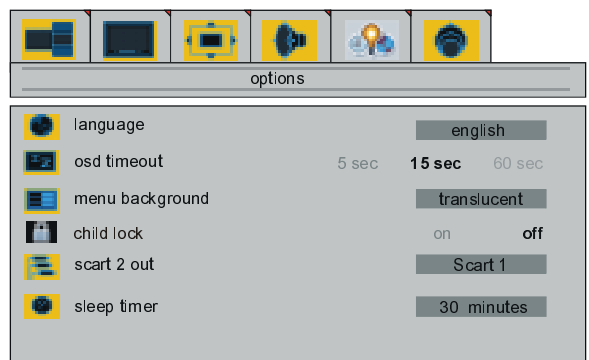

down for various system options

language

By pressing “▲” / “▼” button, select **language**. **"right/left to change language"** is seen on the screen. By pressing “◀” / “▶” button, you can select the language.

vcr

This item is displayed only when TV is in AV mode. By pressing “▲” / “▼” button, select **vcr**. "right/left to change vcr status" is seen on the screen. By pressing “◀” / “▶” button set vcr to **on** or **off**.

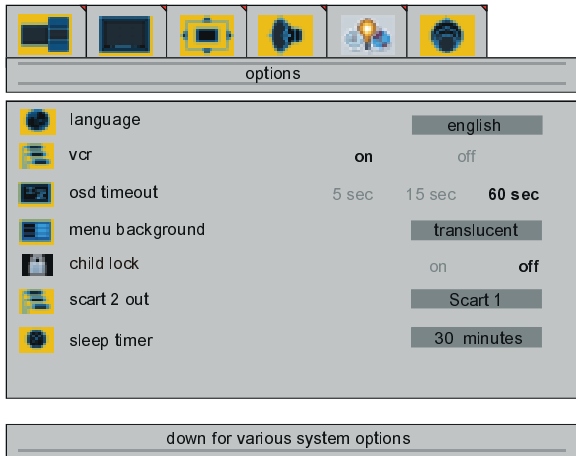

osd timeout

By pressing “▲” / “▼” button, select **osd timeout**. "right/left to change osd timeout" is seen on the screen. By pressing “◀” / “▶” button, you can change osd timeout to **5 sec**, **15 sec** or **60 sec**.

menu background

By pressing “▲” / “▼” button, select **menu background**. "right to change menu background" is seen on the screen. You can change menu background to **translucent** or **opaque** by pressing “▶” button.

child lock

You can use this feature to prevent children turning on TV or changing programs or adjustments etc. without remote control.

By pressing “▲” / “▼” button, select child lock. "right/left to change" is seen on the screen. The child lock feature can be set by “◀” / “▶” button to either **on** or **off**. When **off** is selected, there will be no difference in the operation of your TV. When **on** is selected, the TV can only be controlled by the remote control handset.

scart 2 out

By pressing “▲” / “▼” button, select **scart 2 out**. "right/left to select scart 2 out" is seen on the screen. You can set scart 2 out to **Scart 1**, **tuner** or **FAV** by pressing “◀” / “▶” button.

sleep timer

By pressing “▲” / “▼” button, select **sleep timer**. "adjust sleeptimer" is seen on the screen. The Sleep Timer is used to turn the TV off after a defined period of time after selecting this item. The timer can be programmed between 0 and 120 minutes in steps of 10 minutes. (0, 10, 20, 30, 40, ... , 120)

If sleep timer is activated, at the end of the selected the time, the TV goes automatically to stand-by mode.

settings menu

By pressing “◀” / “▶” button, select the sixth icon. Settings menu appears on the screen.

- If full screen option was selected at the layout menu, the settings menu is seen as below.

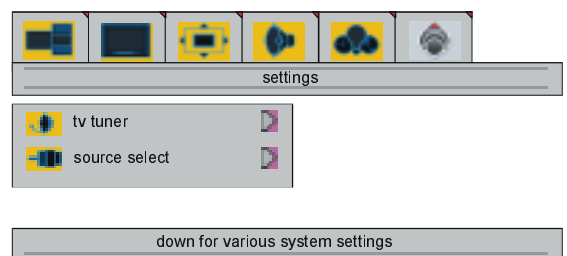

If pip option was selected at the layout menu or in AV mode, the settings menu is seen as below.

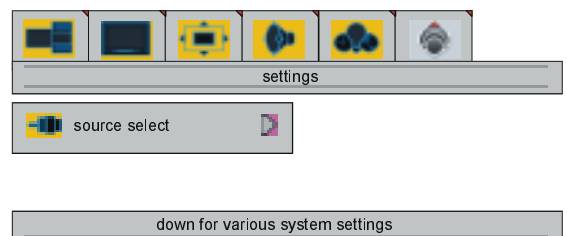

tv tuner

By pressing “▲” / “▼” button, select **tv tuner**. "OK to activate tuner menu" is seen on the screen. By pressing “◀” / “▶” or "OK" button

enter the menu. **tv tuner** menu has two sub-menu named as **aps** and **programming**.

programming menu

By pressing “◀” / “▶” button in **tv tuner** menu select the first icon. Programming menu appears on the screen.

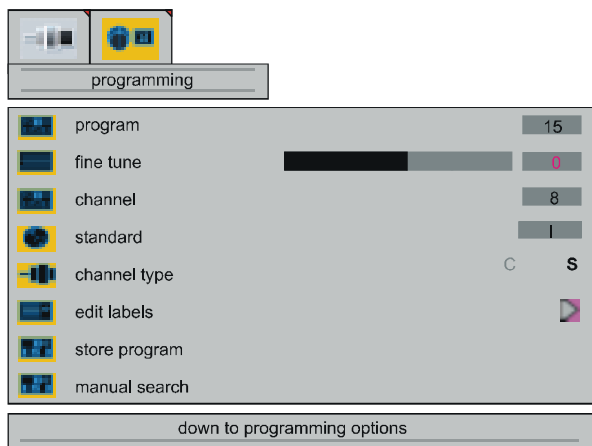

program

By pressing “▲” / “▼” button, select **program**. "right/left to select program" is seen on the screen. By pressing “◀” or “▶” button, you can select the program number. You can also enter a number via digit buttons on the remote control. There are 100 program storage between 0 and 99.

fine tune

By pressing “▲” / “▼” button, select **fine tune**. "right/left to adjust fine tuning" is seen on the screen. By pressing “◀” or “▶” button, you can adjust the tuning. The adjust values are between -50 and +50.

channel

By pressing “▲” / “▼” button, select **channel**. "right/left to change channel" is seen on the screen. By pressing “◀” or “▶” button, you can change the channel number. You can also enter a number via digit buttons on the remote control. The adjust values change according to the **standard** and **channel type**.

standard

By pressing “▲” / “▼” button, select **standard**. "right/left to change standard" is seen on the screen. By pressing “◀” or “▶” button, you can change the standard to **B/G, D/K, I** or **L/L'**.

channel type

By pressing “▲” / “▼” button, select **channel type**. "right/left to change channel type" is seen on the screen. By pressing “◀” or “▶” button, you can change the channel type to **C** or **S**.

edit labels

By pressing “▲” / “▼” button, select **edit labels**. "right/left to edit labels" is seen on the screen. By pressing “◀” / “▶” or “OK” button, you can enter the following menu.

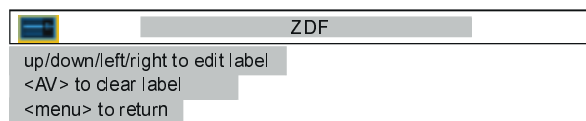

“▲” / “▼” or “◀” / “▶” buttons are used to edit labels.

store program

By pressing “▲” / “▼” button, select **store program**. "right/left to store program" is seen on the screen. By pressing “◀” / “▶” or “OK” button, you can store the program and following menu appears on the screen.

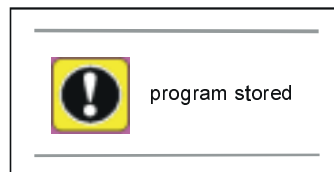

manual search

By pressing “▲” / “▼” button, select **manual search**. "right/left to search" is seen on the screen. By pressing “◀” or “▶” button, you can start program searching and following menu appears on the screen.



aps menu

By pressing “◀ / ▶” button in tv tuner menu select the second icon. aps menu appears on the screen.

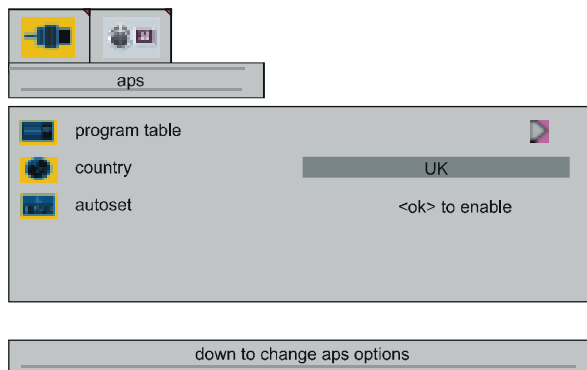

program table

By pressing “▲ / ▼” button, select **program table**. "right/left to enter program table" is seen on the screen. By pressing “◀ / ▶” or “OK” button, you can enter the following program table.

- Program table may be entered only when the layout is **full screen**. You can not enter to program table when layout is **pip screen**.

program table		
1 CNN	11 ----	21 ----
2 RA 2	12 ----	22 ----
3 SAT	13 ----	23 ----
4 RA 3	14 ----	24 ----
5 TV5	15 ----	25 ----
6 ZDF	16 ----	26 ----
7 RA1	17 ----	27 ----
8 C02	18 ----	28 ----
9 S07	19 ----	29 ----
10 C05	20 ----	30 ----

- Delete
- Insert
- Name

Moving cursor to four direction you can reach 30 programmes in the same page. By scrolling the pages up or down by pressing the cursor buttons you can select all the programmes in TV mode (except the AV mode).

In program table, “▲ / ▼” buttons work like "Direction Up" and "Direction Down". By cursor action, programme selection is done automatically.

Programme Number is between 01 and 99. 00 is not displayed on program table. Programme Name has a name string with 5 characters. After autoselect process the Programme Names are set to "C02" or "S07" (channel type and channel number) or name of the tuned channel if defined.

At the bottom of the program table there is a programme sort functions section. Each function is activated by color button (seen above). By **Delete** you can delete programmes that you decided. **Insert** section is for inserting programmes into another programme spaces. **Name** allows changing the programme name.

Delete:

For "Delete" process RED button is pressed. The following warning menu comes to screen. Pressing “MENU” button cancels the activated "Delete" process. Pressing “OK” button erases the selected programme from the programme list, and the programmes below shift one up.

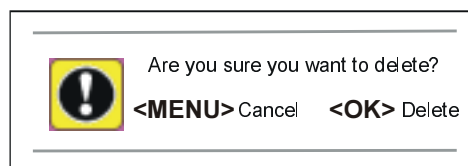

Insert:

Select the program which you want to insert by navigation buttons. Press GREEN button. By cursor buttons move the selected program to the decided programme space and press GREEN button again.

Name:

To change the name of a decided programme, that programme is selected and pressed to the YELLOW button. The following menu comes to screen.



The first letter of the selected name is highlighted. To change that letter “▲” / “▼” button can be used, and to select the other letters, “◀” / “▶” button can be used. If the cursor is at the last letter of the Programme Name, pressing “▶” button moves the cursor at the beginning. On the contrary, if the cursor is at the beginning of the Programme Name, pressing “◀” button moves the cursor at the end.

country

By pressing “▲” / “▼” button, select **country**. "**right/left to change country**" is seen on the screen. By pressing “◀” / “▶” button, you should select the country where you are.

autoset

By pressing “▲” / “▼” button, select **autoset**. "**right/left to start aps function**" is seen on the screen. When “◀” / “▶” or “OK” button is pressed, the following menu comes to the screen. If you want to cancel autoset function, press “MENU” button. You return to **aps** menu. If you press “MENU” button after autoset is started, program table appears on the screen.

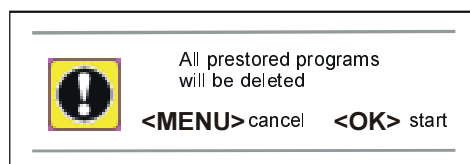

If “OK” button is pressed, autoset function starts and the following menu comes to the screen.

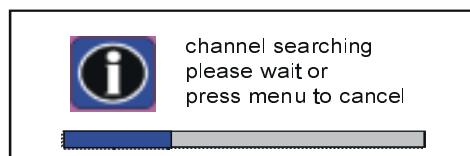

After autoset is finalized, the program table comes to the screen. In the programme table you will see the programme numbers and names assigned to the programmes.

If you do not accept the locations and / or the programme names of programmes, you can change them in **aps** submenu in the settings menu. (See [page 17](#) for Program table explanation.)

source select

By pressing “▲” / “▼” button, select **source select** in **settings** menu. "**<ok> to activate source selection menu**" is seen on the screen. By pressing “◀” / “▶” or “OK” button, you can enter the source select menu.

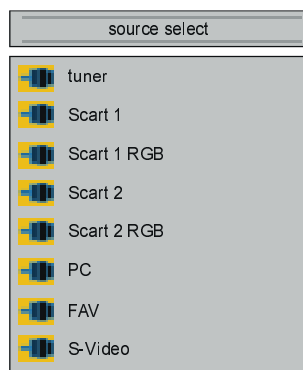

In source select menu, come on one of the sources by pressing “▲” / “▼” button and select it by pressing “▶” button. The source types are **Tuner**, **Scart 1**, **Scart 1 RGB**, **Scart 2**, **Scart 2 RGB**, **PC**, **FAV** and **S-Video**.

Other Features

TV Status

Programme Number, **Programme Name** and **Sound Indicator** are displayed on the upper right side of the screen. **Source** is also displayed with them on the right bottom side of the screen. They are displayed after programme change during 3 seconds or when “**i**” button is pressed.

1 Programme Number

PR_01 Programme Name (5 characters)

These OSD's are displayed when a new programme is entered by digit button, by pressing “**P**▼” or “**P**▲” button or “**BACK**” button.



Pressing “**i**” button when PC mode selected shows sound indicator and the resolution of the screen.

When “**i**” button is pressed twice the cur-

rent time information, captured from Teletext will be displayed on the screen.

Active window switch

By pressing “” button in any modes, PIP window appears on the screen.

In PIP mode “” / “” buttons or “” button are used to select active window.

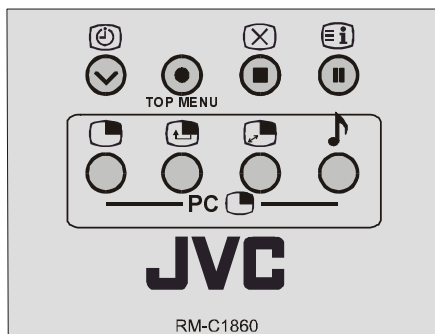

Note: PC screen is not displayed in PIP window.

Freeze Picture

You can freeze the picture on the screen by pressing “OK” button. Press OK button again to back to the moving picture. Display layout should be selected as **full screen** for this feature. At PIP layouts; this function is invalid.

Sleep Timer

Sleep Timer mode OSD is displayed when YELLOW button is pressed.

The Sleep Timer is used to turn the TV off after a defined period of time after selecting this item. The timer can be programmed between 0 and 120 minutes in steps of 10 minutes. (0, 10, 20, 30, 40, ... , 120)

If sleep timer is activated, at the end of the selected the time, the TV goes automatically to stand-by mode.

Sound Modes

The alternatives of the modes are **Mono**, **Stereo**, **Dual A** and **Dual B**. This indicator is displayed under the programme number indicator on the screen. “I-II” button is used to select **Mono**, **Stereo**, **Dual A** or **Dual B**.

MONO

In **Mono** broadcast or in forced-mono (for stereo broadcast).

STEREO

In **Stereo** broadcast.

DUAL A

If dual broadcast detected. **Dual A** is selected in default and also can be selected after **Dual B** by Remote Control.

DUAL B

If **Dual B** selected by Remote Control.



Muting the Sound

Press the “” (muting) button to turn off and on the sound. One of the sound marks below will appear on the upper left side of the screen.

The mark will also appear when the left or Right button pressed.

It is placed in the upper left side of the screen when enabled.

Sound Off   Sound On

When sound is off, pressing “ +” / “- ” buttons restores the previous volume level

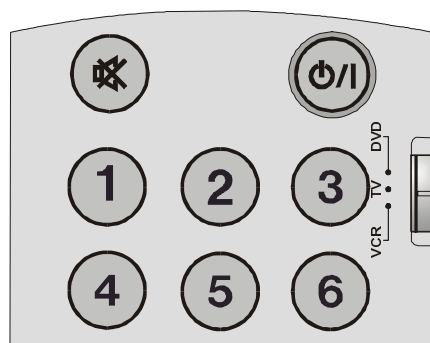

If **PIP layout** is selected, the sound mark is displayed at the upper middle of the PIP window.

Hyper Sound

By selecting Hyper Sound in sound menu or by pressing the “” button on your remote control, Pseudo/Spatial effect can be turned on or off. In Mono transmission the left and right channels will be added at left channel and dummy stereo effect will introduced to end-user.

In stereo transmission it yields a phase dif-

ference between left and right channels. Hyper Sound selection will be displayed on the screen when the TV Status button is pressed or programme is changed.

EXT Modes

By pressing the “AV” button or via **source select** menu, you can switch your TV to EXT modes (except being in Teletext). Pressing this button will consecutively switch the TV in one of the optional EXT modes: **Tuner, Scart 1, Scart 1 RGB, Scart 2, Scart 2 RGB, PC, FAV** and **SVideo**.

While watching VCR; **vcr** item in **options** menu should be set to **on**.

Zoom Modes

Zoom mode bar is displayed when RED button(ZOOM) is pressed. You can change the screen size according to the picture aspect ratio. Select the optimum one from the following **ZOOM** modes.

AUTO:

When a **WSS (Wide Screen Signalling)** signal, which shows the aspect ratio of the picture, is included in the broadcast signal or the signal from an external device, the TV automatically changes the **ZOOM** mode to **16:9 ZOOM** mode **PANORAMIC** or **FULL** mode according to the **WSS** signal.

- When the **AUTO** mode does not function correctly due to poor **WSS** signal quality or when you want to change the **ZOOM** mode, change to another **ZOOM** mode manually.

Using the different screen formats

Press the “◀” or “▶” button to select the different modes: Auto, Full, 16:9 Zoom, 16:9 Zoom Subtitle, Regular, Panoramic, 14:9 Zoom modes.

FULL:

This uniformly stretches the left and right sides of a normal picture (4:3 aspect ratio) to fill the wide TV screen.

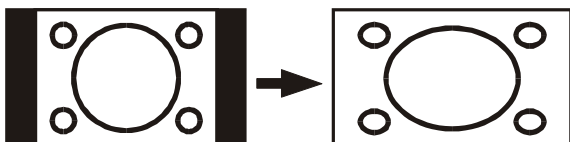

- For 16:9 aspect ratio pictures that have been squeezed into a normal picture (4:3 aspect ratio), use the **FULL** mode to restore the picture to its original shape.

16:9 ZOOM:

This zooms up the wide picture (16:9 aspect ratio) to the full screen.

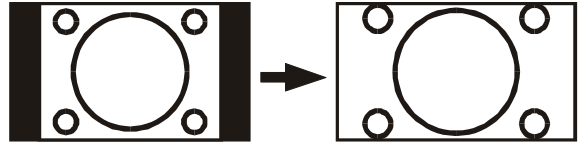

16:9 ZOOM SUBTITLE:

This zooms up the wide picture (16:9 aspect ratio) with subtitles to the full screen.

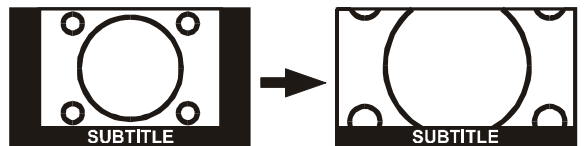

REGULAR:

Use to view a normal picture (4:3 aspect ratio) as this is its original shape.

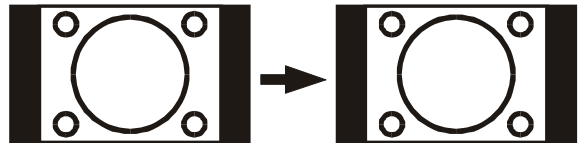

PANORAMIC:

This stretches the left and right sides of a normal picture (4:3 aspect ratio) to fill the screen, without making the picture appear unnatural.

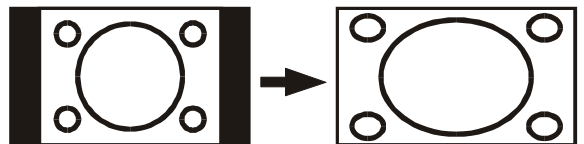

The top and bottom of the picture are slightly cut off.

14:9 ZOOM:

This zooms up the wide picture (14:9 aspect ratio) to the upper and lower limits of the screen.

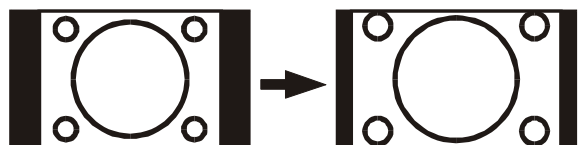

Teletext

Teletext is an information system that displays text on your TV screen. Using the Teletext information system you can view a page of information on a subject that is available in the list of contents (index).

The menu is not available in text mode.

Contrast, brightness or colour control is not available, but volume control is available in text mode.

To Operate Teletext

- Select a TV station on which Teletext is being transmitted.
- Press “☰” button. Usually the list of contents (index) is displayed on the screen.

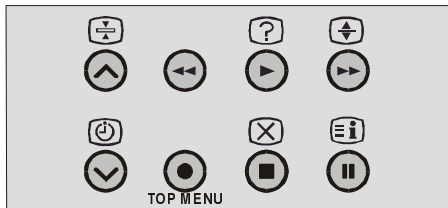

To Select a Page Of Teletext

- Press the appropriate digit buttons for the required Teletext page number.

The selected page number is displayed at the top left corner of the screen. The Teletext page counter searches until the selected page number is located, so that the desired page is displayed on the screen.

- Press “P^” button to move the Teletext screen forward one page at a time.
- Press “P∨” button to move the Teletext screen backward one page at a time.

To Select Index Page

- To select the page number of the index (generally page 100), press “☰i” button.

Searching for a teletext page while watching TV

- In the Teletext mode pressing “☒” button will switch the screen to the TV mode. In the TV mode enter a page number using digit buttons. As you enter last digit of page num-

ber, “☰” sign will replace the page number and flash until the entered page number is found. Then the page number will replace “☰” sign again. Now you can display this teletext page pressing “☒” button

To Select Double Height Text

- Press “☒” button for the top half of the information page to be displayed in double height text.
- Press “☒” button again for the bottom half of the information page to be displayed in double height text.
- Press “☒” button once more for the full page of normal height text.

To Reveal “Concealed” Information

- Pressing “?” button once will reveal answers on a quiz or games page.
- Pressing “?” button again will conceal the revealed answers.

To Stop Automatic Page Change

The teletext page you have selected may contain more information than what is on the screen; the rest of the information will be displayed after a period of time.

- Press “☒” button to stop the automatic page change.
- Press “☒” button again to allow the next page to be displayed.

To Select A Subcode Page

Subcode pages are subsections of long Teletext pages that can only be displayed on the screen one section at a time.

- Select the required Teletext page.
- Press “☒” button.
- Select the required subcode page number by pressing four digit buttons (e.g. 0001).
- If the selected subcode page is not displayed in a short time, press “☒” button. TV programme will be displayed on the screen.

- Teletext page number will be displayed on the upper left corner of the screen when the selected page is found.
- Press “**X**” button to display the selected Teletext page.

To Exit Teletext

- Press “**≡**” button. The screen will switch to TV mode.

Fastext

Your TV supports the 10 page Teletext system. When the page number of any of the 10 pages in memory is entered, the system will not search for the requested page; instead it will display the page automatically.

- Press “**P**^” button to move the Teletext screen forward one page at a time.
- Press “**P**∨” button to move the Teletext screen backward one page at a time.

For Fastext

The subject-heading for the information may have a particular color.

- Press an appropriate **RED, GREEN, YELLOW** or **BLUE** button in order to reach the relevant page quickly.

For TOP text

TOP text mode of operation will be activated automatically according to the transmission.

- If TOP text transmission is present, color coded buttons will appear in status row.
- If TOP text transmission is not present, status row will not appear.

The subject-heading for information may be located in colored box.

In Top mode the “**P**∨ or **P**^” commands will request the next or previous page respectively. If TOP text transmission is not available, in case of operation of these commands, wraparound occurs. For example page 100 appears to be one greater than page 199.

Connect Peripheral Equipment

There is a wide range of audio and video equipment that can be connected to your TV.

The following connection diagrams show you where the different equipment should be connected at the back or right side of the TV.

Via The Euroconnector

TFT TV has 2 Euroconnector sockets. If you want to connect peripherals (e.g. video, decoder, etc.) which have Euroconnectors, to the TV, use **Scart 1** or **Scart 2** inputs.

If an external device is connected via Euroconnector sockets TV is switched to EXT mode automatically. If the signal is RGB, select RGB in the source select menu to view picture. If the external device is connected to **Scart 1**, choose **Scart 1 RGB**. If the external device is connected to **Scart 2**, choose **Scart 2 RGB**.

Via Ant Input

If you want to connect to your TV, peripherals like video recorders or decoders, but the device you want to connect does not have Euroconnector, you should connect it to the ANT input of the TV.

If the VCR is connected via antenna input it is suggested to use the Programme 0.

Decoder

Cable TV offers you a wide choice of programs. Most of them are free, others are to be paid for by the viewer. This means that you will need to subscribe to the broadcasting organisation whose programmes you wish to receive. This organisation will supply you a corresponding decoder unit to allow the programmes to be unscrambled.

For further information ask your dealer. See also the booklet supplied with your decoder.

Connect a decoder with an aerial socket to the TV

- Connect the aerial cable.

Connect a decoder without an aerial socket to the TV

- Connect the decoder to the TV with a eurocable to **Scart 1**.

TV And Video Recorder

- Connect the aerial cables.

Better picture quality can be obtained if you also connect a eurocable to **SCART** sockets.

Playback NTSC

To use this option you can;

- Connect NTSC VCR player to Euroconnector at the rear side of the TV.
- Connect NTSC VCR player to RCA Jacks at the right side of the TV.

Then, press “**AV**” button to select proper source.

Copy Facility

Source selection for **VCR** recording.

- Select **options** menu.
- Select **scart 2 out** source pressing “▲” / “▼” button.
- Select **Scart 1** to copy the picture from tuner.
- Select **Scart 2** to copy the picture from **Tuner, FAV** or **Scart 1**.

Search For And Store The Test Signal Of The Video Recorder

- Unplug the aerial cable from the aerial socket “**ANT**” of your video recorder.
- Switch on your TV and put the video recorder on the test signal. (See the booklet for your video recorder.)
- Enter the **tv tuner** menu in **settings** menu. Enter the **programming** menu in **tv tuner** menu and select **manual search**.
- Search for the test signal of your video recorder in the same way as you searched for and stored the TV signals. See **programming** menu. Store the test signal under programme number 0.
- Replace the aerial cable in the aerial socket “**ANT**” of your video recorder once you have stored the test signal.

Camera And Camcorder to Connect to FAV Input

Connect your camera or camcorder FAV input at the right side of the TV.

- Connect your equipment to the TV via **VIDEO** (yellow), **AUDIO R** (red) and **AUDIO L** (white) inputs. You should connect the jacks to the input in the same color.

To Connect to SVideo Input

Connect your camera or camcorder SVideo input at the right side of the TV.

- Connect your equipment to the TV via SVideo input and audio inputs of FAV inputs by using SVideo cables.

Connect The Decoder To The Video Recorder

Some video recorders have a special euroconnector for decoder.

- Connect a eurocable to the euroconnector of your decoder and to the special euroconnector of your video recorder. See also the booklet of your video recorder.
- To connect your video recorder to the TV, see TV and Video Recorder section.

If you want to connect more equipment to your TV, consult your dealer.

Connecting Headphones

Use the stereo headphone socket at the right side of the TV, to connect headphones.

You can adjust the headphones volume and sound mode from the audio menu. See [page 14](#) for details.

Antenna Connections

Outdoor Antenna Connections

VHF antenna
Method 1

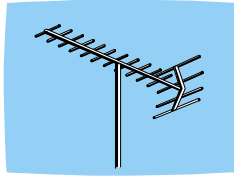

Round 75 ohm coaxial cable

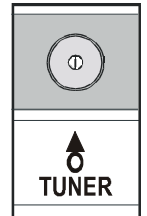

Rear of TV

VHF/UHF antenna
Method 2

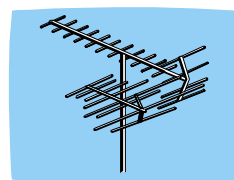

Flat 300-ohm twin lead cable

Round 75-ohm coaxial cable

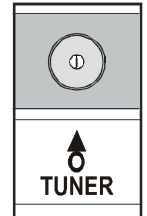

Rear of TV

Connect Peripheral Equipment

HEADPHONE



AUDIO

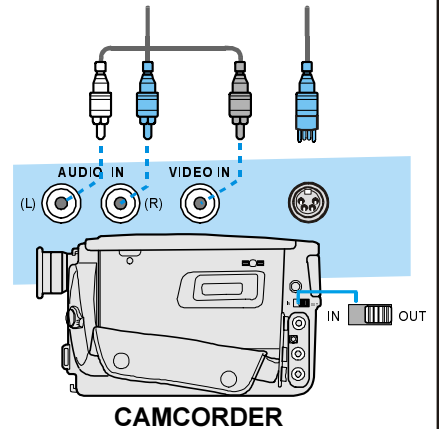
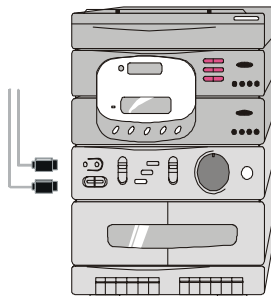

CAMCORDER

VIDEO

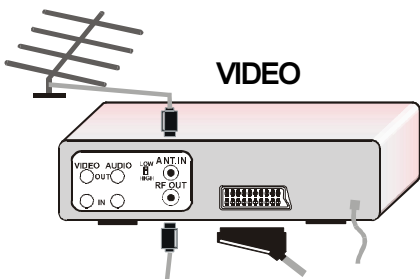

DECODER

FOR SATELLITE RECEIVER

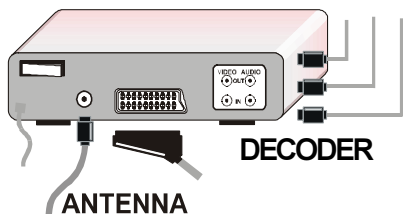

ANTENNA

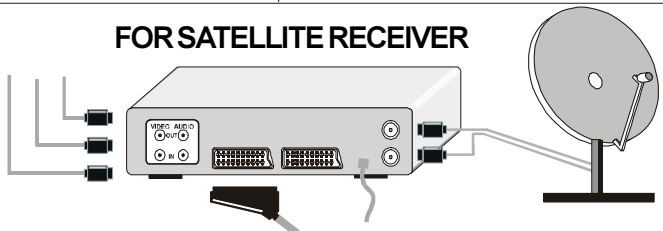

PC Input Typical Display Modes

The display has a maximum resolution of 1280 x 768, vertical sync. frequency range of 50-75 Hz and a horizontal sync. frequency range of 30-69 KHz.

The following table is an illustration of some of the typical video display modes.

Mode	Resolution		Frequency	
	Horizontal	Vertical	Hor. (kHz)	Ver. (Hz)
1	640	400	31.5	60
2	640	480	37.9	72
3	640	480	37.5	75
4	720	400	31.5	70
5	800	600	37.9	60
6	800	600	48.1	72
7	800	600	46.9	75
8	1024	768	48.4	60
9	1024	768	56.5	70
10	1024	768	60.0	75
11	1280	768	47,6	60

The native resolution of the TFT-LCD Panel is 1024 x 768. Therefore using Mode 10 is advised to get the best PC input display quality.

PIP Combination Restrictions

Main PIP	TUNER	SCART 1	SCART 2	SCART 1 RGB	SCART 2 RGB	FAV	PC	S-VIDEO
TUNER								
SCART 1								
SCART 2								
SCART 1 RGB								
SCART 2 RGB								
FAV								
PC								
S-VIDEO								

 This condition is not possible

Tips

Care Of The Screen

Clean the screen with a slightly damp, soft cloth. Do not use abrasive solvents as they may damage the TV screen coating layer.

Poor Picture

Have you selected the correct TV system? Is your TV set or house aerial located too close to the loudspeakers, non-earthed audio equipment or neon lights, etc.?

Mountains or high buildings can cause double pictures or ghost images. Sometimes you can improve the picture quality by changing the direction of the aerial.

Is the picture or Teletext unrecognisable? Check if you have entered the correct frequency.

The picture quality may degrade when two peripherals are connected to the TV at the same time. In such a case, disconnect one of the peripherals.

No Picture

Is the aerial connected properly? Are the plugs connected tightly to the aerial socket? Is the aerial cable damaged? Are suitable plugs used to connect the aerial? If you are in doubt, consult your dealer.

No Picture means that your TV is not receiving any transmission. Have you pressed the correct buttons on the remote control? Try once more.

PC Picture

If no PC picture appears, check the D-SUB cable is connected properly. Check that your PC's resolution set correctly. See [page 25](#) for supported modes.

Sound

You can not hear any sound. Did you perhaps interrupt the sound, pressing "ⓧ" button? Are external speakers connected to the TV?

Sound is coming from only one of the speakers. Is the balance set to one direction extreme? See **audio** menu.

Remote Control

Your TV no longer responds to the remote control. Perhaps the batteries are exhausted. Replace the batteries.

Have you selected the wrong menu? Press "**BACK**" button to return to TV mode or press "**MENU**" button to return to the previous menu.

No solution

Switch your TV set off and on. If this does not work, call the service personnel; never attempt to repair it yourself.

For users in the UK:

If you have any problems setting up your new TV, please call the **JVC** Helpline on 0870330 5000

For users in the Republic of Ireland:

If you have any problems setting up your new TV, please call the **JVC** Helpline on 1890 - 582500

Specifications

Item	Model	LT-30E45SJ
Broadcasting Systems		PAL SECAM, B/G, D/K, I/I', L/L'
Channels and Frequencies		VHF (VL) 46,25 MHz - 168,25 MHz VHF (VH) 175,25 MHz - 463,25 MHz UHF 471,25 MHz - 863,25 MHz Cable TV (S1-S20/ S21-S41)
Input Signal		Video: Analog 0,7 Vp-p 75 ohm positive Sync: TTL Level positive or negative, Seperate sync.
Horizontal Timing		30 - 69 KHz
Vertical Timing		50 - 75 Khz
Dot Rate		78,75 MHz max.
Panel Size		29,5" (measured diagonally)
Visible Picture Size		643 mm horizontal x 386 mm vertical
Display Resolution		1280 x 768 max. (WXGA)
Number of Preset Channels		100
Channel Indicator		On Screen Display (OSD)
RF Aerial Output		75 Ohm (unbalanced)
Power Requirements		220-240 V AC, 50 Hz
Power Consumption (W)		150 W (max) / STAND-BY <4W
Sound Systems		German , Nicam Stereo
Audio Output		2 x 8 W _{RMS} (%10 THD)
EXT-1 Terminal		Euroconnector (21-pin, SCART 1) (bottom of the cabinet) • Video Input, Audio L/R Inputs and RGB inputs are available. • TV broadcast outputs (Video and Audio L/R) are available.
EXT-2 Terminal		Euroconnector (21-pin, SCART 2) (bottom of the cabinet) • Video Input, S-VIDEO (Y/C) input, Audio L/R and RGB inputs are available. • Video and Audio L/R outputs are available. • T-V LINK functions are available.
EXT-3 Terminal		RCA connectors x 3 (side of the cabinet) S-VIDEO connector x 1 (side of the cabinet) • Video input, S-VIDEO (Y/C) input and Audio L/R inputs are available.
Audio Output		RCA connectors x 2 (bottom of the cabinet) • Audio L-R Line Outs are available
PC IN terminal		Analog RGB D-SUB 15 x 1 • PC signal is available (refer to page 25 for details of the signals which can be input)
PC AUDIO IN terminal		Stereo mini-jack (3.5 mm diameter)
Dimensions (W x H x D)		847 mm x 522 mm x 260 mm 847 mm x 490 mm x 102 mm (TV only)
Weight		14.8 kg (with stand) / 13 kg (TV only)
Accessories		Remote control unit x 1 (RM-C1860) / AA/R6 dry cell battery x 2 Power cord x 1
Headphone jack		Stereo mini-jack (3.5 mm diameter)



JVC

ENGLISH
DEUTSCH
FRANÇAIS
ITALIANO

JVC

InteriArt
LT-30E45SU

WIDE LCD PANEL TV

INSTRUCTIONS

BREITBILD-LCD-TV
TÉLÉVISEUR À GRAND ÉCRAN LCD
TV A PIENO SCHERMO LCD

BEDIENUNGSANLEITUNG
MANUEL D'INSTRUCTIONS
ISTRUZIONI



50 0594 94

1004MKH-VT-VT



Contents

How to remove the stand	2
Important Information	3
TV Control Buttons and Terminals	4
Remote Control Buttons	6
Preparation	7
Safety Precautions	7
Before Switching On Your TV	9
Switching The TV ON/OFF	9
Operating The TV	10
Other Features	18
Teletext.....	21
Connect Peripheral Equipment	22
Antenna Connections	24
PC Input Typical Display Modes	25
PIP Combination Restrictions	25
Tips	26
Specifications	27

WARNING

- Do not allow children to hang from the TV, place their elbows on the TV or lean against the TV. Doing so may cause the TV to fall over and lead to injuries.

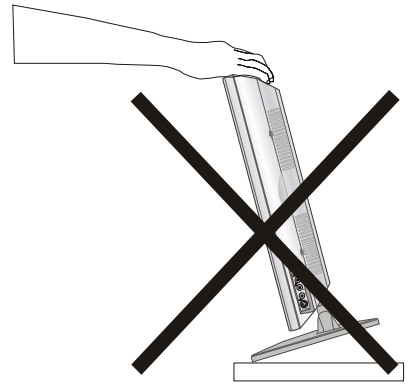

CAUTION:

- The TV screen may be damaged if the TV is carried as shown in the diagram below.
The TV should always be carried by two people.

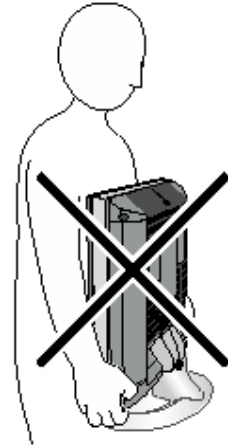

How to remove the stand

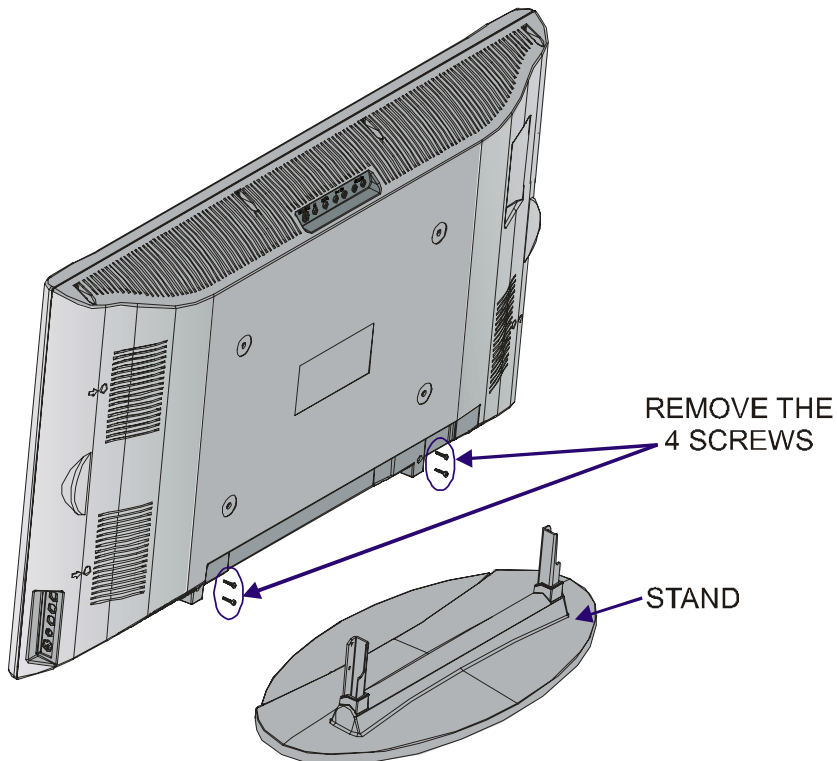

Important Information

Please take note

EXCLUSION CLAUSE

JVC shall under no circumstances be liable for loss and/or damage to the product caused by:

- fire;
- earthquake;
- accidental damage;
- intentional misuse of the product;
- use of the product in improper conditions;
- loss and/or damage caused to the product whilst in the possession of a third party;
- any damage or loss caused as a result of the owner's failure and/or neglect to follow the instructions set out in the owner's manual;
- any loss or damage caused directly as a result of misuse or malfunction of the product when used simultaneously with associated equipment;

Furthermore, under no circumstances shall JVC be liable for any consequential loss and/or damage including but not limited to the following, loss of profit, interruption of business, the loss of recorded data whether caused during normal operation or misuse of the product.

WARNING! NEVER LEAVE A STATIONARY IMAGE ON THE SCREEN

If stationary images generated by TELETEXT, CHANNEL IDENTIFICATION LOGOS, COMPUTER DISPLAYS, VIDEO GAMES, ON SCREEN MENUS, etc. are left on the TV screen for any length of time, they could become permanently ingrained.

If you use your television to display completely still images, or moving pictures which have a permanent still image superimposed e.g. broadcast network logos, it is always advisable to reduce BOTH the brightness and contrast settings.

Care and disposal

Cleaning the screen and cabinet...

Turn off the power, clean the screen and cabinet with a soft, dry cloth. We recommend that you do not use any proprietary polishes or solvents on the screen or cabinet as this may cause damage.

Disposal...

When the set reaches the end of its useful life please dispose of it in accordance with Local Government Regulations or at a recycling centre.

TV Control Buttons and Terminals

FRONT VIEW

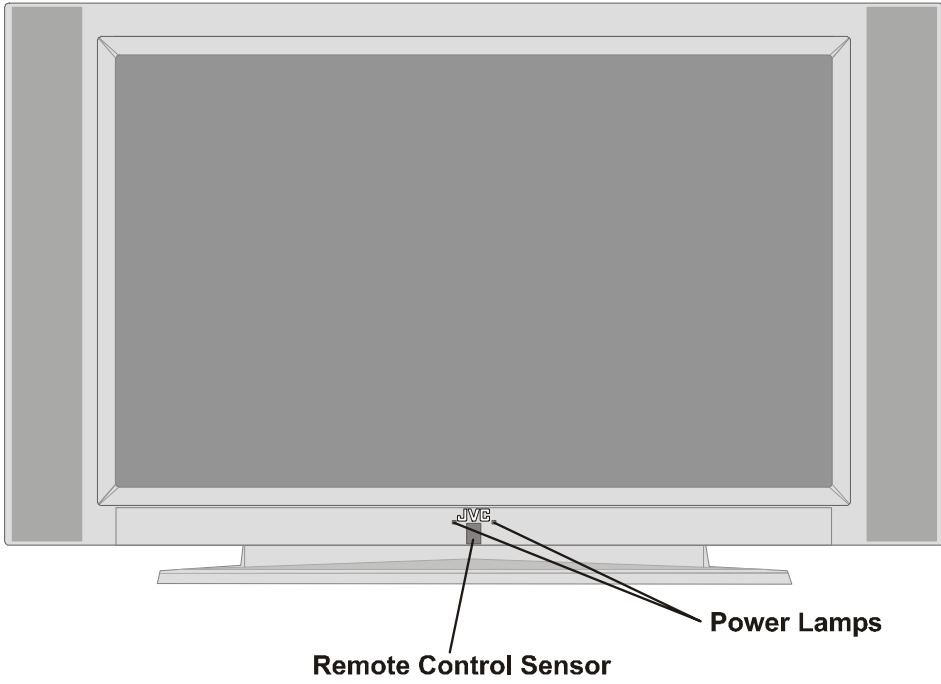

REAR VIEW

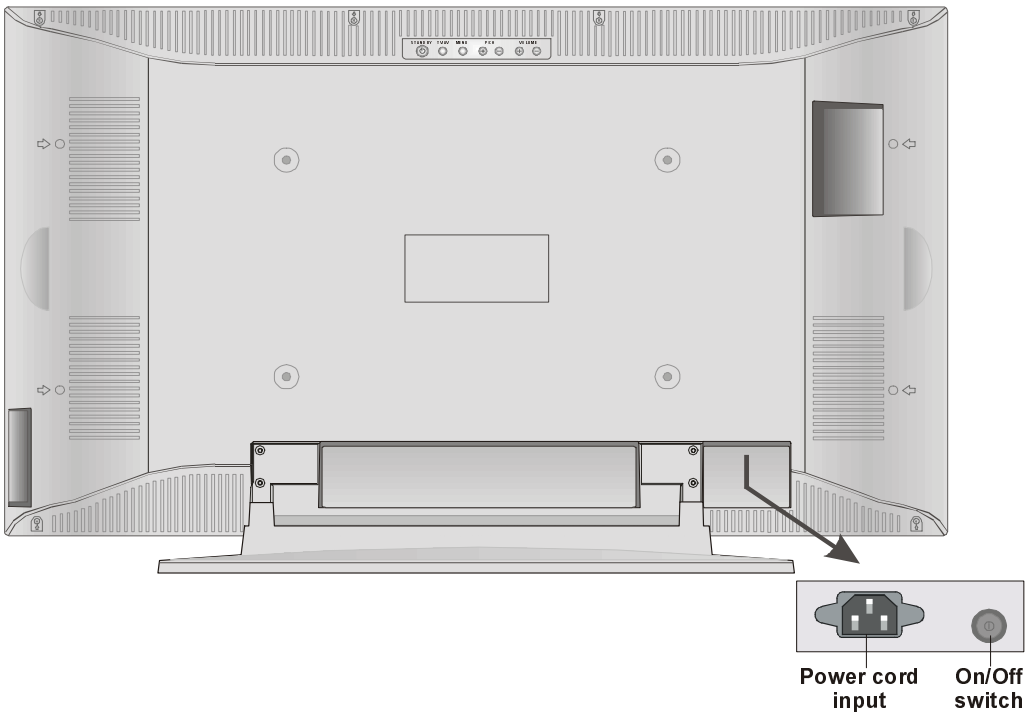

- Ⓐ Headphone
- Ⓑ Audio Input (Left, Right)
- Ⓒ Video Input
- Ⓓ S-VHS Input
- Ⓔ STAND BY button
- Ⓕ TV/AV button
- Ⓖ MENU button
- Ⓗ Program Up, Program Down buttons
- Ⓘ Volume Up, Volume Down buttons
- Ⓙ Power cord input
- Ⓚ On/Off switch
- Ⓛ Antenna
- Ⓜ Audio Line Out L, R
- Ⓝ Scart 1
- Ⓞ Scart 2
- Ⓟ Audio In (for PC)
- Ⓡ PC Input

FrontAV

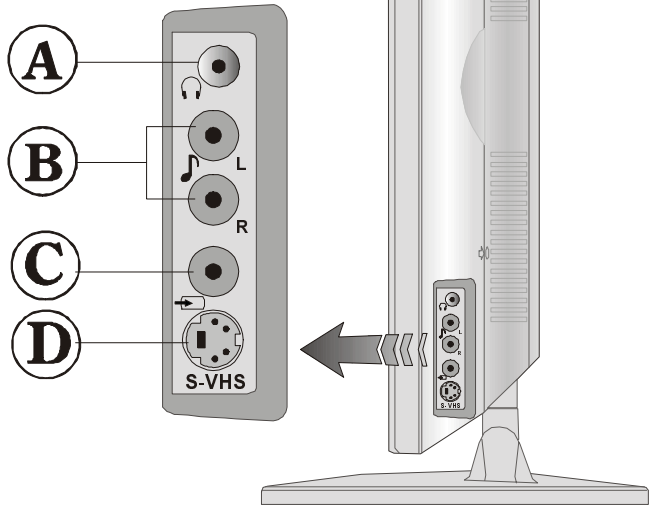

TV Control Buttons

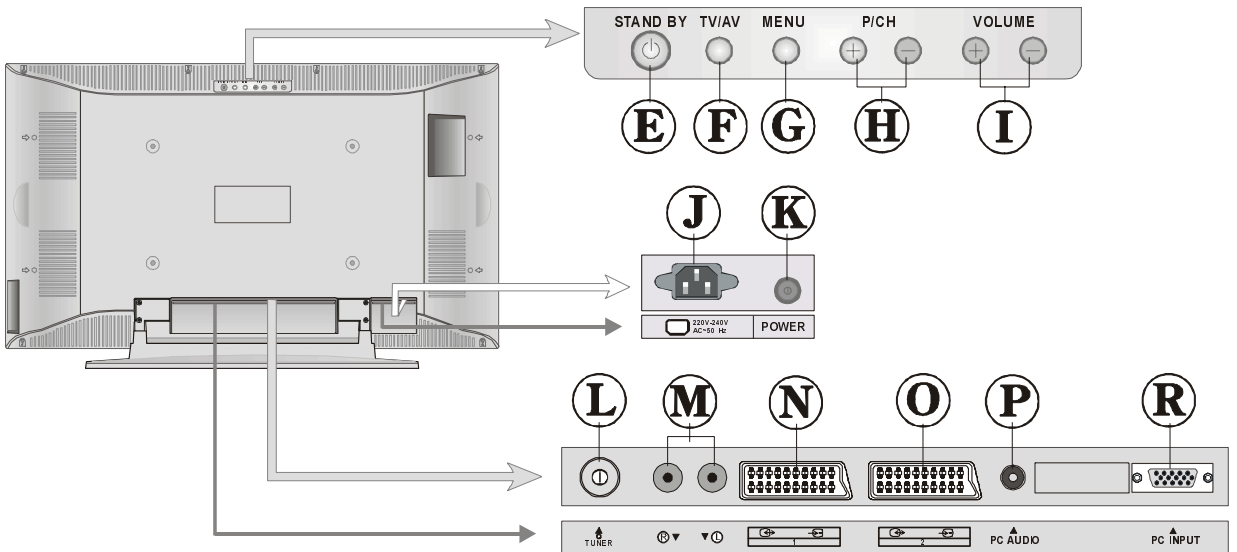

Remote Control Buttons

- ① = (Stand By) button
- ② TV / VCR / DVD Switch
- ③ Number buttons
- ④ **AV** button (Tuner, Scart 1, Scart 1 RGB, Scart 2, Scart 2 RGB, PC, FAV, SVideo)
- ⑤ **BLUE / PICTURE** Mode button
- ⑥ **YELLOW** / Sleep Timer button
- ⑦ **MENU** button
- ⑧ = Cursor Up button
- ⑨ OK button
- ⑩ = Cursor Right button
- ⑪ **BACK** button
- ⑫ = Volume + / - buttons
- ⑬ Teletext / VCR / DVD Control buttons
- ⑭ PIP Control Buttons
- ⑮ P / buttons
- ⑯ = Cursor Down button
- ⑰ = Teletext Button
- ⑱ I/II = Stereo / Bilingual button
- ⑳ **GREEN** / Hyper Sound On/Off button
- ㉑ **RED / ZOOM** Mode button
- ㉒ = Information Button
- ㉓ = Mute button

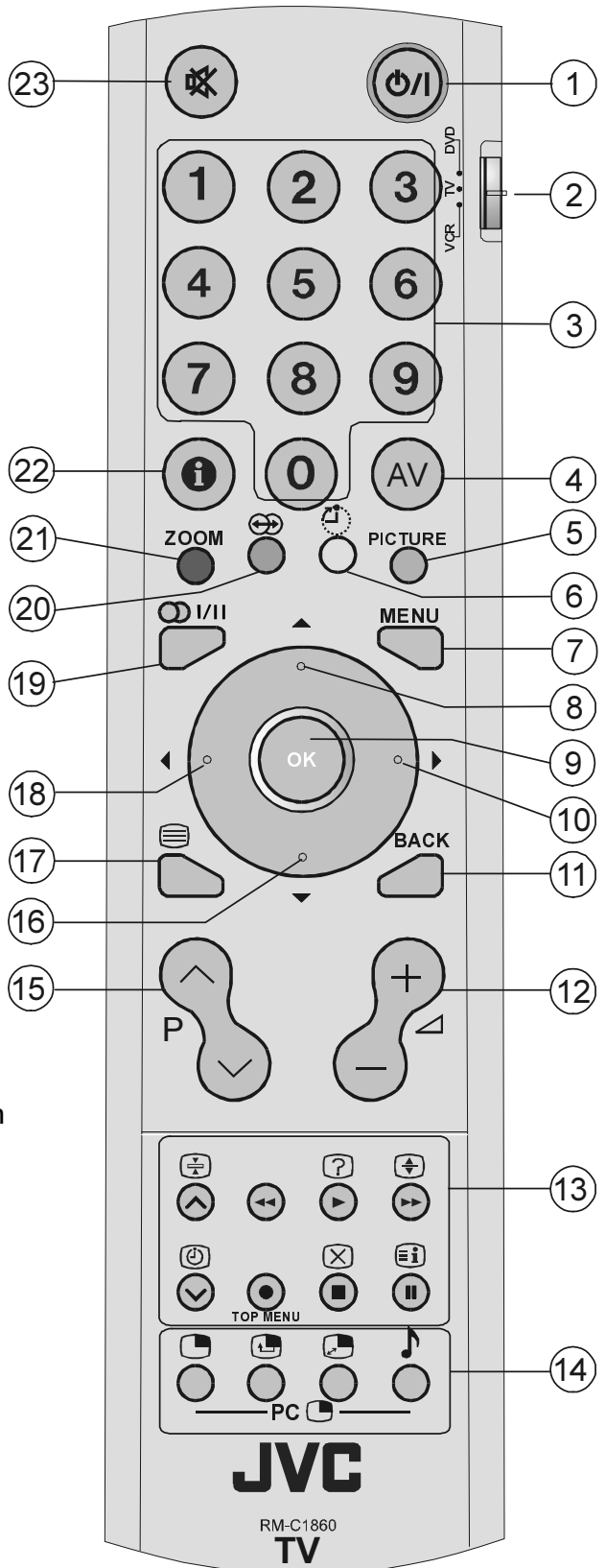

Preparation

For ventilation, leave a space of at least 10 cm free all around the set. To prevent any fault and unsafe situations, please do not place any objects on top of the set.

Use this apparatus in tropical and/or moderate climates.

Features

- It is a remote controlled color television.
- 100 programmes from VHF, UHF bands or cable channels can be preset.
- It can tune cable channels.
- Controlling the TV is very easy by its menu driven system.
- It has 2 Euroconnector sockets for external devices (such as video, video games, audio set, etc.)
- Stereo sound system (German+Nicam).
- Full function Teletext .
Fastext (10 Pages), TOP text.
- It is possible to connect headphone.
- Direct channel access.
- A.P.S. (Automatic Programming System).
- All programmes can be named.
- Sleep timer.
- Automatic sound mute when no transmission.
- Auto, Full, 16:9 Zoom, 16:9 Zoom Subtitle, Regular, Panoramic, 14:9 Zoom modes.
Auto switch WSS (Wide Screen Signaling).
- NTSC Playback.
- Front SVHS is available.
- Front AV in is available.
- It has VGA connector for external devices such as computer.
- It has PIP functions.
- TV Picture in PC
- When no valid signal is detected, after 5 minutes the TV switches itself automatically to stand-by mode.
- PC input (Support Up to WXGA 1280 x 768)
- 1 SVHS Input and 1 RCA AV Input are available.

- Stereo PC Audio Input
- 4H Comb Filter
- Audio Line Out

Panel Features

- High resolution, 30-inch TFT LCD display.
- WXGA resolution (1280 x 768)
- Contrast ratio (600:1 typical)
- Brightness (typical) 550 cd/m².
- Response time (typical) 25 msec.
- Viewing angle (typical) 170° (horizontal) and 170° (vertical).
- Display color 16.7 Million.

Safety Precautions

1. Power Source

The receiver should be operated only from a **220 - 240 V AC, 50 Hz.** outlet. Ensure you select the correct voltage setting for your convenience.

2. Power Cord

The power supply cord should be placed so that it is not likely to be walked on or pinched by items placed upon them or against it. Pay particular attention to cord where it enters the plug, power outlet, and the point where it exits from the receiver.

3. Moisture and Water

Do not use this equipment in a humid and damp place (avoid the bathroom, the sink in the kitchen, and near the washing machine). Do not expose this equipment to rain or water, as this may be dangerous and do not place objects filled with liquids on top. Avoid from dripping or splashing.

4. Cleaning

Before cleaning, unplug the receiver from the main supply, outlet. Do not use liquid or aerosol cleaners. Use soft and dry cloth.

5. Ventilation

The slots and openings on the receiver are intended for ventilation and to ensure reliable operation. To prevent overheating, these open-

ings must not be blocked or covered in any way.

6. Lightning

In case of storm and lightning or when going on holiday, disconnect the power cord from the wall outlet.

7. Replacement Part

When replacement parts are required, be sure the service technician has used replacement parts which are specified by the manufacturer or have the same specifications as the original one. Unauthorised substitutions may result in fire, electrical shock, or other hazards.

8. Servicing

Please refer all servicing to qualified personnel. Do not remove cover as this may result in electric shock.

9. Naked Flame Sources

Do not place naked flame sources on the apparatus.

WARNING: When the device is not in use for a long time, disconnect from power.

Instructions for waste disposal:

- Packaging and packaging aids are recyclable and should principally be recycled. Packaging materials, such as foil bag, must be kept away from children.
- Battery, including those which is heavy metal-free, should not be disposed of with household waste. Please dispose of used battery in an environmentally sound manner. Find out about the legal regulations which apply in your area.
- Cold cathode fluorescent lamp in LCD PANEL contains a small amount of mercury, please follow local ordinates or regulations for disposal.

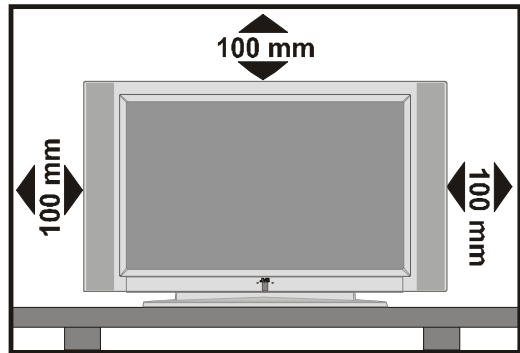
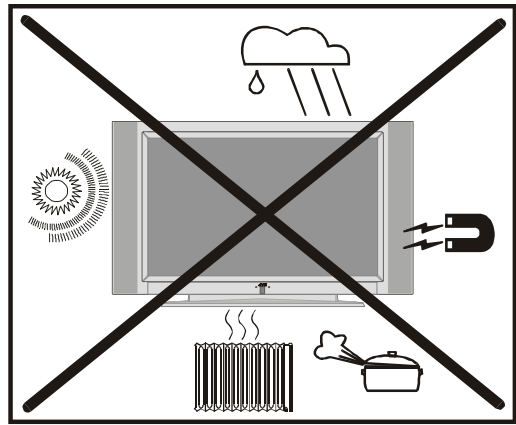

"The LCD panel is very high technology product with about a million thin film transistors, giving you fine picture details. Occasionally, a few non-active pixels may appear on the screen as a fixed point of blue, green or red. Please note that this does not affect the performance of your product."

"DO NOT LEAVE YOUR TV AT STAND-BY OR OPERATING WHEN YOU LEAVE YOUR HOUSE"

Before Switching On Your TV

Power Connection

IMPORTANT: The TV set is designed to operate on **220 - 240 V AC, 50 Hz.**

- After unpacking, allow the TV set to reach the ambient room temperature before you connect the set to the mains.

Connections To The RF Input Socket

- Connect the aerial or cable TV plug to the RF input socket located at the back of the TV and connect the cable plug coming out from the TV out socket located at the devices (VCR, DVB etc.) to this socket as well.

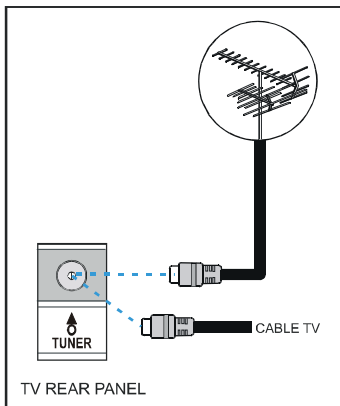

How To Connect Other Devices

IMPORTANT: Switch off the TV before connecting any external device.

Sockets for external connections are at the back and side of the TV. For connection of other devices via Euroconnector refer to the manuals of the related devices.

Inserting Batteries In The Remote Control Handset

- Place the batteries in the right directions as seen below.
- Remove the battery cover located on the back of the handset by gently pulling upwards from the indicated part.
- Insert two **AA/R6** dry cell or equivalent type of batteries inside.
- Replace the battery cover.

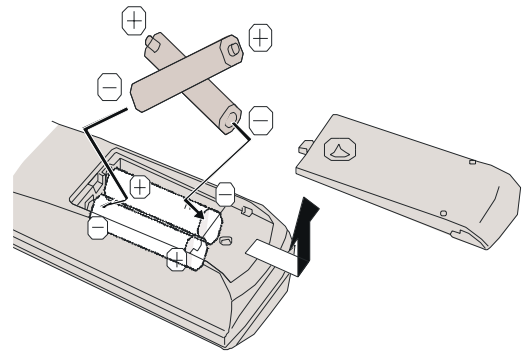

NOTE: Remove batteries from remote control handset when it is not to be used for a long period. Otherwise it can be damaged due to any leakage of batteries.

Switching The TV ON/OFF

To switch the TV on:

Your TV will switch on in two steps:

- 1- Connect the power supply cord to the system. Press On/Off switch at the rear of the TV. Then the TV switches itself to stand-by mode and the power lamp becomes red located on the front of the TV.
- 2- To switch on the TV from stand-by mode either:

Press a digit button on the remote control so that a programme number is selected,

or,

Press "**⏻ / I**", "**-P/CH**" or "**P/CH+**" button at the top of the TV or press "**P∨**" or "**P∧**" button on the remote control, so that last switched off programme is selected.

By either ways the TV will switch on and the power lamp becomes green.

To switch the TV off:

- Press the "stand-by" button on the remote control, so the TV will switch to stand-by mode and the power lamp will become **RED**,
- or,

Press the "**⏻ / I**" button located on the top of the TV, so the TV will switch off and the power lamp will become **RED**.

To switch the TV off completely press On/Off switch at the rear of the TV and remove the mains plug from the socket.

Operating The TV

You can operate your TV both using the remote control handset and onset buttons.

Initial APS (Automatic Programming System)

The following menu will be displayed on the screen when you turn on your TV for the first time. APS, searches and sorts all channels and stores them automatically on your TV, according to the transmission of programme systems in your area.

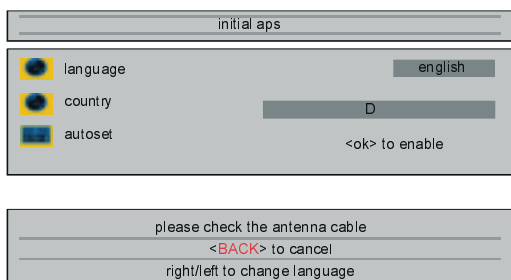

To cancel APS before starting, press “**BACK**” button.

First of all choose **language** and **country** by using “▲” / “▼” and “◀” / “▶” buttons. This, will effect the sort process in APS. To start aps select **autoselect**, by using “▲” / “▼” buttons and press “◀” / “▶” or “**OK**” button. While APS is running, no picture appears.



After APS is finalized, the programme table will be appeared on the screen. In the programme table you will see the programme numbers and names assigned to the programmes.

If you do not accept the locations and / or the programme names of programmes, you can change them in aps submenu in the settings menu. (See [page 17](#) for Program table explanation.)

Operating with the buttons on the TV set

Volume setting and programme selection can be made by using the buttons at the control panel on the top of the TV.

Volume Setting

Press “**VOLUME -**” button to decrease volume or “**VOLUME +**” button to increase volume, so a volume level scale (slider) will be displayed at the middle of the bottom on the screen.

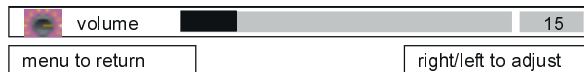

Programme Selecting

Press “**P/CH+**” button to select the next programme or “**PCH-**” button to select the previous programme.

“**P/CH+ / PCH-**” and “**VOLUME + / VOLUME -**” buttons on the TV are used as navigation buttons in menu.

Entering The Menu

Press “**MENU**” button at the control panel on the top of the TV to enter the menu.

“**P/CH+ / PCH-**” and “**VOLUME + / VOLUME -**” buttons at the control panel on the top of the TV work as direction buttons in the menu.

EXT Mode

Press “**TV/AV**” button at the control panel on the top of the TV to switch your TV to EXT mode (See **EXT Modes** in [page 20](#)).

Operating With Remote Control

The remote control handset of your TV is designed to control all the functions of the model you selected. The functions will be described in accordance with the menu system of your TV.

Functions of the menu system are described in Menu System section.

Volume Setting

Press “▲ +” button to increase volume. Press “- ▼” button to decrease volume. A volume level bar will be displayed at the middle of the bottom on the screen.

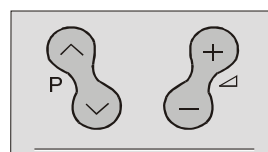

Programme Selecting (Previous or next programme)

- Press “**P**∨” button to select the previous programme.
- Press “**P**∧” button to select the next programme.

Programme Selecting (direct access):

Press digit buttons on the remote control handset to select programmes between 0 and 9. TV will switch to the selected program after a short delay.

- For a two digit program number enter the second digit after pressing the first digit within 2 seconds.

Menu System

Your TV has been designed with a menu system to provide an easy manipulation of a multifunction system. Press the “**MENU**” button to enter the menu.

Press “◀ / ▶” button to select a menu title and then “▲ / ▼” button to select a menu item and “◀ / ▶” or “**OK**” button to enter the submenu. Press “**MENU**” button to return to the previous menu. Press “**BACK**” button to exit from the menu.

layout menu

By pressing “◀ / ▶” button, select the first icon. Layout menu appears on the screen.

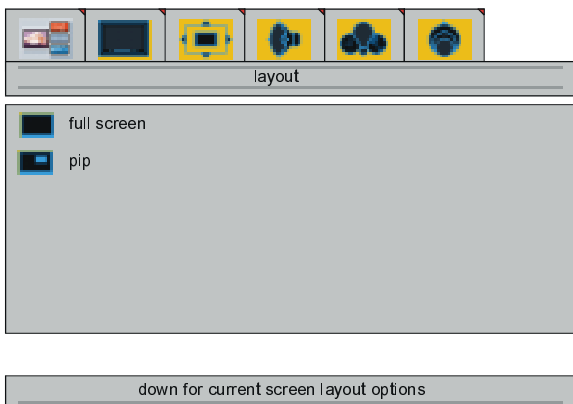

full screen

By pressing “▲ / ▼” button, select **full screen**. “<ok> activates one window layout” is seen on the screen. Press “▶” or “**OK**” but-

ton. One programme is displayed on the whole screen at this option.

pip

By pressing “▲ / ▼” button, select **pip**. “<ok> activates pip window layout” is seen on the screen. Press “▶” or “**OK**” button. The first programme can be watched on the background. The second programme is seen at the pip window.

PIP picture is displayed on the screen also with “◻” button.

Programme in the PIP window is increased / decreased by “**P**∨ / **P**∧”, digit buttons or AV button when PIP window is selected. PIP window is removed from the screen by “◻” button.

picture menu

By pressing “◀ / ▶” button, select the second icon. Picture menu appears on the screen.

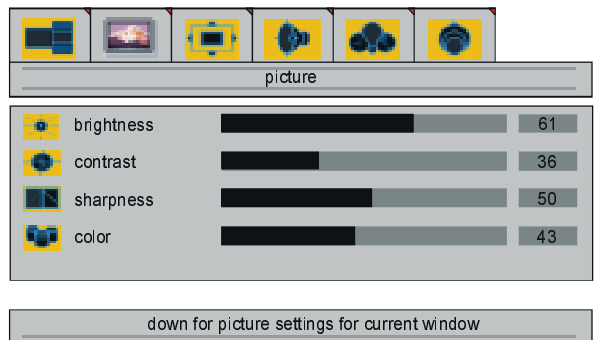

brightness

By pressing “▲ / ▼” button, select **brightness**. “right/left to adjust brightness” is seen on the screen. Press “▶” button to increase brightness. Press “◀” button to decrease brightness. Brightness level can be adjusted between 0 and 100.

contrast

By pressing “▲ / ▼” button, select **contrast**. “right/left to adjust contrast” is seen on the screen. Press “▶” button to increase contrast. Press “◀” button to decrease contrast. Contrast level can be adjusted between 0 and 100.

sharpness

By pressing “▲” / “▼” button, select **sharpness**. “right/left to change sharpness” is seen on the screen. Press “▶” button to increase sharpness. Press “◀” button to decrease sharpness. Sharpness level can be adjusted between 0 and 8.

color

By pressing “▲” / “▼” button, select **color**. “right/left to adjust color” is seen on the screen. Press “▶” button to increase color. Press “◀” button to decrease color. Color level can be adjusted between 0 and 100.

tint

This item is displayed in picture menu when TV is in AV mode and at NTSC signal. By pressing “▲” / “▼” button, select **tint**. “right/left to adjust tint” is seen on the screen. Press “▶” button to increase tint. Press “◀” button to decrease tint. Tint level can be adjusted between 0 and 100.

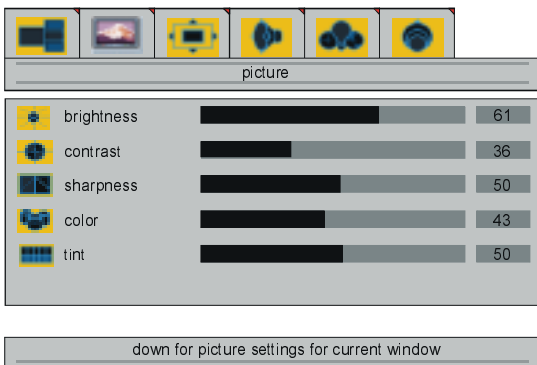

When TV is in AV mode; picture menu items (brightness, contrast, sharpness and color) may require re-adjustment.

When PC is Connected To TV:

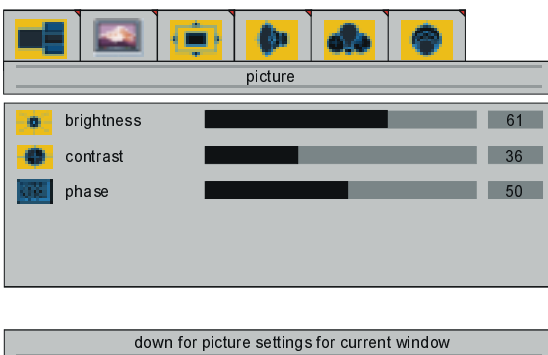

brightness

By pressing “▲” / “▼” button, select **brightness**. “right/left to adjust brightness” is seen on the screen. Press “▶” button to increase brightness. Press “◀” button to decrease brightness. Brightness level can be adjusted between 0 and 100.

contrast

By pressing “▲” / “▼” button, select **contrast**. “right/left to adjust contrast” is seen on the screen. Press “▶” button to increase contrast. Press “◀” button to decrease contrast. Contrast level can be adjusted between 0 and 100.

phase

By pressing “▲” / “▼” button, select **phase**. “right/left to adjust phase” is seen on the screen. Press “▶” button to increase phase. Press “◀” button to decrease phase. Phase level can be adjusted between 0 and 100.

window menu

By pressing “◀” / “▶” button, select the third icon. Window menu appears on the screen.

- If full screen option was selected at the layout menu, the window menu is seen as below.

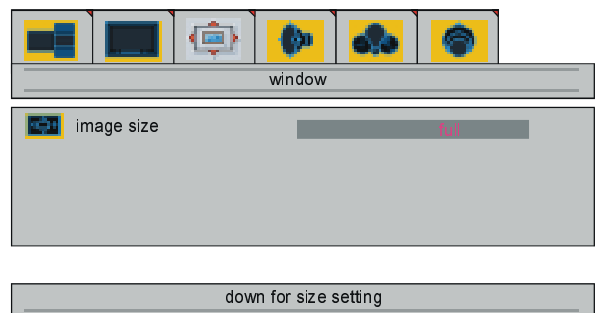

image size

By pressing “▲” / “▼” button, select **image size**. “right/left to change image size” is seen on the screen. By pressing “◀” / “▶” button, you can change image size to Auto, Full, 16:9 Zoom, 16:9 Zoom Subtitle, Regular, Panoramic, 14:9 Zoom modes.

You can enter image size directly by pressing “ZOOM” button.

- If pip option was selected, the window menu is seen as below.

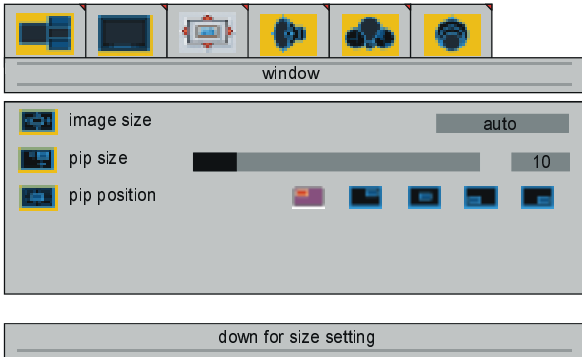

image size

By pressing “▲” / “▼” button, select **image size**. "right/left to change image size" is seen on the screen. By pressing “◀” / “▶” button, you can change image size to **full**, **regular** and **auto**.

You can enter image size directly by pressing “ZOOM” button. See [Page 20](#) for details.

pip size

By pressing “▲” / “▼” button, select **pip size**. "right/left to adjust PIP size" is seen on the screen. Press “▶” button to increase pip size.

Press “◀” button to decrease pip size. Pip size can be adjusted between 0 and 100.

When PIP is activated you can enter the pip size directly by pressing “” button.

pip position

By pressing “▲” / “▼” button, select **pip position**. "right/left to adjust PIP position" is seen on the screen. By pressing “◀” / “▶” button, you can change the pip position as left top, right top, middle, left bottom or right bottom (as seen on the menu above).

When PIP is activated you can change pip position directly by pressing "" button.

When PC Is Connected To TV

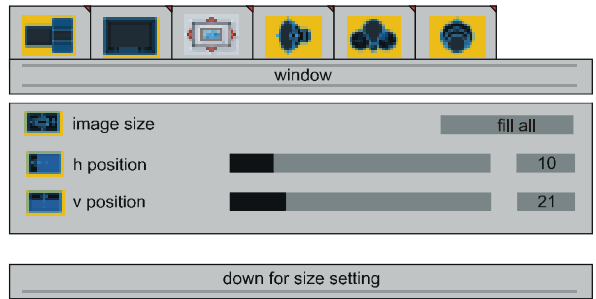

image size

By pressing “▲” / “▼” button, select **image size**. "right/left to change image size" is seen on the screen. By pressing “◀” / “▶” button, you can change image size to **Fill all**, **Fill 1:1** and **Fill aspect**.

h position

By pressing “▲” / “▼” button, select **h position**. "right/left to adjust h position" is seen on the screen. Press “▶” button to slide the screen to the left. Press “◀” button to slide screen to the right. **h position** can be adjusted between 0 and 100.

v position

By pressing “▲” / “▼” button, select **v position**. "right/left to adjust v position" is seen on the screen. Press “▶” button to slide the screen to up. Press “◀” button to slide screen to down. **v position** can be adjusted between 0 and 100.

audio menu

By pressing “◀” / “▶” button, select the fourth icon. Audio menu appears on the screen.

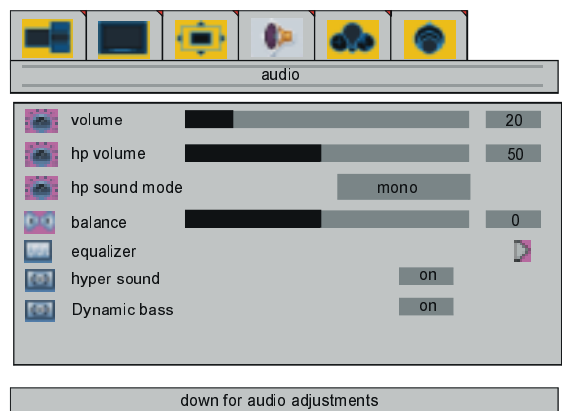

volume

By pressing “▲” / “▼” button, select **volume**. **"right/left to adjust volume"** is seen on the screen. Press “▶” button to increase volume level. Press “◀” button to decrease volume level. Volume level can be adjusted between 0 and 63.

hp volume

By pressing “▲” / “▼” button, select **hp volume**. **"right/left to adjust hp volume"** is seen on the screen. Press “▶” button to increase headphone volume level. Press “◀” button to decrease headphone volume level. Hp volume (headphone volume) level can be adjusted between 0 and 100.

hp sound mode

By pressing “▲” / “▼” button, select **hp sound mode**. **"right to adjust hp sound mode"** is seen on the screen. Press “◀” / “▶” button change hp sound mode.

Hp sound mode is used to identify sound mode of the headphone. hp sound mode can be set to **mono**, **stereo**, **dual a** or **dual b** according to the transmission.

balance

By pressing “▲” / “▼” button, select **balance**. **"right/left to adjust balance"** is seen on the screen. Press “▶” button to increase balance rightward. Press “◀” button to decrease balance leftward. Balance level can be adjusted between -50 and 50.

equalizer

By pressing “▲” / “▼” button, select **equalizer**. **"right/left for equalizer settings"** is seen on the screen. Press “◀” / “▶” or “OK” button to enter equalizer menu. In equalizer menu the sound mode can be changed to **user**, **flat**, **pop**, **rock**, **jazz** and **classic** by pressing “◀” / “▶” button. Equalizer menu settings can be changed only when **sound mode** is **user**. Select the desired frequency by “▲” / “▼” button and increase or decrease the frequency gain by pressing “◀” / “▶” button.

“MENU” button to exit the equalizer menu.

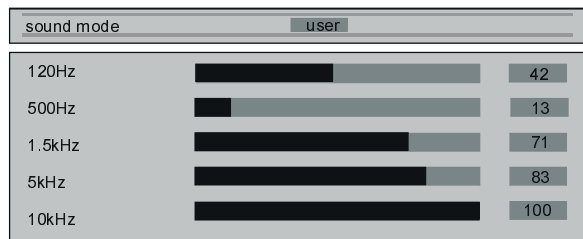

Frequency	Gain
120Hz	42
500Hz	13
1.5kHz	71
5kHz	83
10kHz	100

hyper sound

It is used to gain saloon effect to the sound.

By pressing “▲” / “▼” button, select **hyper sound**. **"right/left for wide sound off/stereo/mono"** is seen on the screen. By pressing “◀” / “▶” button set to hyper sound **on** to activate it or **off** to deactivate it.

dynamic bass

Dynamic Bass is used to increase bass effect of the TV set.

By pressing “▲” / “▼” button, select **dynamic bass**. **"right/left for dynamic bass on/off"** is seen on the screen. By pressing “◀” / “▶” button set to dynamic bass **on** to activate it or **off** to deactivate it.

options menu

By pressing “◀” / “▶” button, select the fifth icon. Options menu appears on the screen.

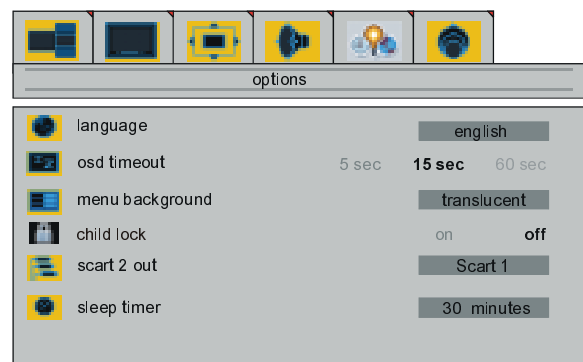

Option	Value
language	english
osd timeout	5 sec 15 sec 60 sec
menu background	translucent
child lock	on off
scart 2 out	Scart 1
sleep timer	30 minutes

down for various system options

language

By pressing “▲” / “▼” button, select **language**. **"right/left to change language"** is seen on the screen. By pressing “◀” / “▶” button, you can select the language.

vcr

This item is displayed only when TV is in AV mode. By pressing “▲” / “▼” button, select **vcr**. "right/left to change vcr status" is seen on the screen. By pressing “◀” / “▶” button set vcr to **on** or **off**.

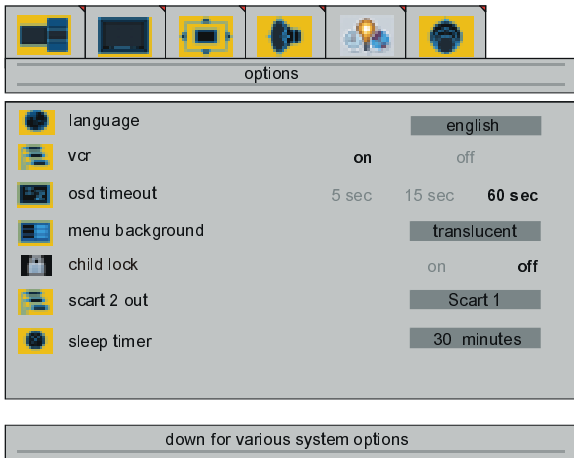

osd timeout

By pressing “▲” / “▼” button, select **osd timeout**. "right/left to change osd timeout" is seen on the screen. By pressing “◀” / “▶” button, you can change osd timeout to **5 sec**, **15 sec** or **60 sec**.

menu background

By pressing “▲” / “▼” button, select **menu background**. "right to change menu background" is seen on the screen. You can change menu background to **translucent** or **opaque** by pressing “▶” button.

child lock

You can use this feature to prevent children turning on TV or changing programs or adjustments etc. without remote control.

By pressing “▲” / “▼” button, select child lock. "right/left to change" is seen on the screen. The child lock feature can be set by “◀” / “▶” button to either **on** or **off**. When **off** is selected, there will be no difference in the operation of your TV. When **on** is selected, the TV can only be controlled by the remote control handset.

scart 2 out

By pressing “▲” / “▼” button, select **scart 2 out**. "right/left to select scart 2 out" is seen on the screen. You can set scart 2 out to **Scart 1**, **tuner** or **FAV** by pressing “◀” / “▶” button.

sleep timer

By pressing “▲” / “▼” button, select **sleep timer**. "adjust sleeptimer" is seen on the screen. The Sleep Timer is used to turn the TV off after a defined period of time after selecting this item. The timer can be programmed between 0 and 120 minutes in steps of 10 minutes. (0, 10, 20, 30, 40, ... , 120)

If sleep timer is activated, at the end of the selected the time, the TV goes automatically to stand-by mode.

settings menu

By pressing “◀” / “▶” button, select the sixth icon. Settings menu appears on the screen.

- If full screen option was selected at the layout menu, the settings menu is seen as below.

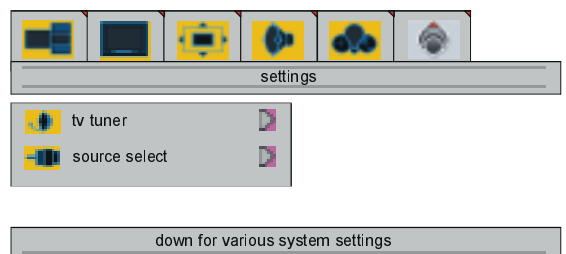

If pip option was selected at the layout menu or in AV mode, the settings menu is seen as below.

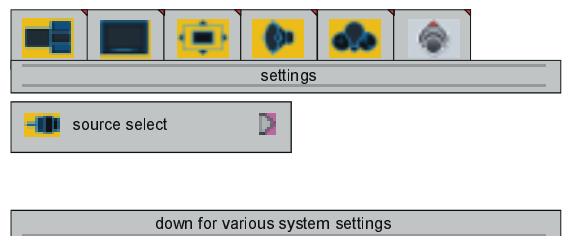

tv tuner

By pressing “▲” / “▼” button, select **tv tuner**. "OK to activate tuner menu" is seen on the screen. By pressing “◀” / “▶” or "OK" button

enter the menu. **tv tuner** menu has two sub-menu named as **aps** and **programming**.

programming menu

By pressing “◀“ / “▶” button in **tv tuner** menu select the first icon. Programming menu appears on the screen.

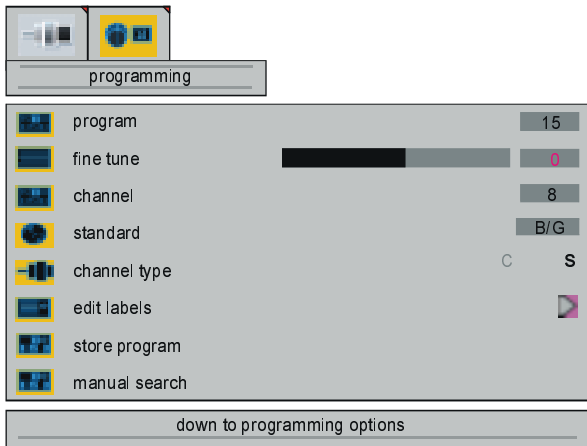

program

By pressing “▲“ / “▼” button, select **program**. "right/left to select program" is seen on the screen. By pressing “◀“ or “▶” button, you can select the program number. You can also enter a number via digit buttons on the remote control. There are 100 program storage between 0 and 99.

fine tune

By pressing “▲“ / “▼” button, select **fine tune**. "right/left to adjust fine tuning" is seen on the screen. By pressing “◀“ or “▶” button, you can adjust the tuning. The adjust values are between -50 and +50.

channel

By pressing “▲“ / “▼” button, select **channel**. "right/left to change channel" is seen on the screen. By pressing “◀“ or “▶” button, you can change the channel number. You can also enter a number via digit buttons on the remote control. The adjust values change according to the **standard** and **channel type**.

standard

By pressing “▲“ / “▼” button, select **standard**. "right/left to change standard" is seen on the screen. By pressing “◀“ or “▶” button, you can change the standard to **B/G, D/K, I** or **L/L**.

channel type

By pressing “▲“ / “▼” button, select **channel type**. "right/left to change channel type" is seen on the screen. By pressing “◀“ or “▶” button, you can change the channel type to **C** or **S**.

edit labels

By pressing “▲“ / “▼” button, select **edit labels**. "right/left to edit labels" is seen on the screen. By pressing “◀“ / “▶” or “OK” button, you can enter the following menu.

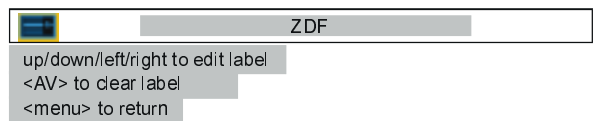

“▲“ / “▼” or “◀“ / “▶” buttons are used to edit labels.

store program

By pressing “▲“ / “▼” button, select **store program**. "right/left to store program" is seen on the screen. By pressing “◀“ / “▶” or “OK” button, you can store the program and following menu appears on the screen.

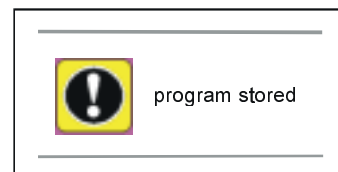

manual search

By pressing “▲“ / “▼” button, select **manual search**. "right/left to search" is seen on the screen. By pressing “◀“ or “▶” button, you can start program searching and following menu appears on the screen.



aps menu

By pressing “◀ / ▶” button in tv tuner menu select the second icon. aps menu appears on the screen.

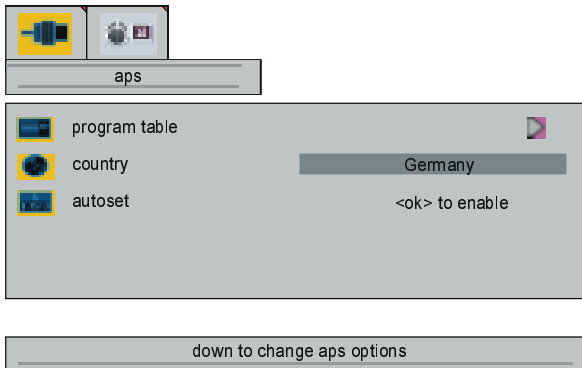

program table

By pressing “▲ / ▼” button, select **program table**. "right/left to enter program table" is seen on the screen. By pressing “◀ / ▶” or “OK” button, you can enter the following program table.

- Program table may be entered only when the layout is **full screen**. You can not enter to program table when layout is **pip screen**.

program table		
1 CNN	11 ----	21 ----
2 RA12	12 ----	22 ----
3 SAT	13 ----	23 ----
4 RA13	14 ----	24 ----
5 TV5	15 ----	25 ----
6 ZDF	16 ----	26 ----
7 RA1	17 ----	27 ----
8 C02	18 ----	28 ----
9 S07	19 ----	29 ----
10 C05	20 ----	30 ----

● Delete
 ● Insert
 ● Name

Moving cursor to four direction you can reach 30 programmes in the same page. By scrolling the pages up or down by pressing the cursor buttons you can select all the programmes in TV mode (except the AV mode).

In program table, “▲ / ▼” buttons work like "Direction Up" and "Direction Down". By cursor action, programme selection is done automatically.

Programme Number is between 01 and 99. 00 is not displayed on program table. Programme Name has a name string with 5 characters. After autaset process the Programme Names are set to "C02" or "S07" (channel type and channel number) or name of the tuned channel if defined.

At the bottom of the program table there is a programme sort functions section. Each function is activated by color button (seen above). By **Delete** you can delete programmes that you decided. **Insert** section is for inserting programmes into another programme spaces. **Name** allows changing the programme name.

Delete:

For "Delete" process RED button is pressed. The following warning menu comes to screen. Pressing “MENU” button cancels the activated "Delete" process. Pressing “OK” button erases the selected programme from the programme list, and the programmes below shift one up.

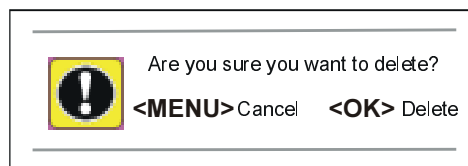

Insert:

Select the program which you want to insert by navigation buttons. Press GREEN button. By cursor buttons move the selected program to the decided programme space and press GREEN button again.

Name:

To change the name of a decided programme, that programme is selected and pressed to the YELLOW button. The following menu comes to screen.



The first letter of the selected name is highlighted. To change that letter “▲” / “▼” button can be used, and to select the other letters, “◀” / “▶” button can be used. If the cursor is at the last letter of the Programme Name, pressing “▶” button moves the cursor at the beginning. On the contrary, if the cursor is at the beginning of the Programme Name, pressing “◀” button moves the cursor at the end.

country

By pressing “▲” / “▼” button, select **country**. "right/left to change country" is seen on the screen. By pressing “◀” / “▶” button, you should select the country where you are.

autoset

By pressing “▲” / “▼” button, select **autoset**. "right/left to start aps function" is seen on the screen. When “◀” / “▶” or “OK” button is pressed, the following menu comes to the screen. If you want to cancel autoset function, press “MENU” button. You return to **aps** menu. If you press “MENU” button after autoset is started, program table appears on the screen.

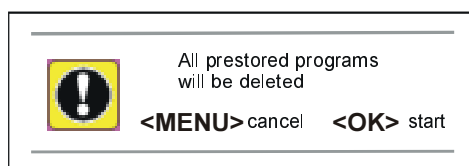

If “OK” button is pressed, autoset function starts and the following menu comes to the screen.

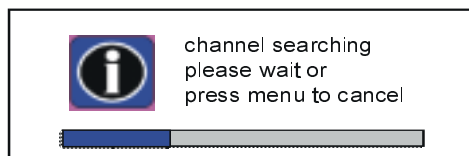

After autoset is finalized, the program table comes to the screen. In the programme table you will see the programme numbers and names assigned to the programmes.

If you do not accept the locations and / or the programme names of programmes, you can change them in **aps** submenu in the settings menu. (See [page 17](#) for Program table explanation.)

source select

By pressing “▲” / “▼” button, select **source select** in **settings** menu. "<ok> to activate source selection menu" is seen on the screen. By pressing “◀” / “▶” or “OK” button, you can enter the source select menu.

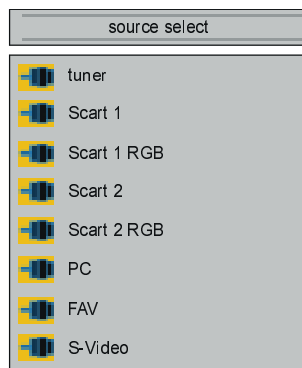

In source select menu, come on one of the sources by pressing “▲” / “▼” button and select it by pressing “▶” button. The source types are **Tuner**, **Scart 1**, **Scart 1 RGB**, **Scart 2**, **Scart 2 RGB**, **PC**, **FAV** and **S-Video**.

Other Features

TV Status

Programme Number, **Programme Name** and **Sound Indicator** are displayed on the upper right side of the screen. **Source** is also displayed with them on the right bottom side of the screen. They are displayed after programme change during 3 seconds or when “i” button is pressed.

1 Programme Number

PR_01 Programme Name (5 characters)

These OSD's are displayed when a new programme is entered by digit button, by pressing “P▼” or “P▲” button or “BACK” button.



Pressing “i” button when PC mode selected shows sound indicator and the resolution of the screen.

When “i” button is pressed twice the cur-

rent time information, captured from Teletext will be displayed on the screen.

Active window switch

By pressing “” button in any modes, PIP window appears on the screen.

In PIP mode “” / “” buttons or “” button are used to select active window.

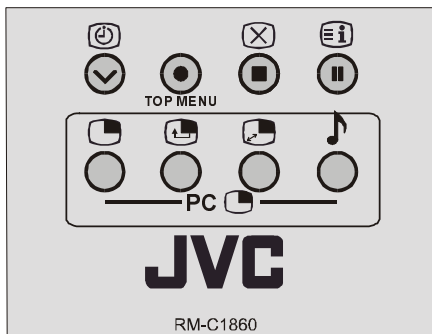

Note: PC screen is not displayed in PIP window.

Freeze Picture

You can freeze the picture on the screen by pressing “OK” button. Press OK button again to back to the moving picture. Display layout should be selected as **full screen** for this feature. At PIP layouts; this function is invalid.

Sleep Timer

Sleep Timer mode OSD is displayed when YELLOW button is pressed.

The Sleep Timer is used to turn the TV off after a defined period of time after selecting this item. The timer can be programmed between 0 and 120 minutes in steps of 10 minutes. (0, 10, 20, 30, 40, ... , 120)

If sleep timer is activated, at the end of the selected the time, the TV goes automatically to stand-by mode.

Sound Modes

The alternatives of the modes are **Mono**, **Stereo**, **Dual A** and **Dual B**. This indicator is displayed under the programme number indicator on the screen. “I-II” button is used to select **Mono**, **Stereo**, **Dual A** or **Dual B**.

MONO

In **Mono** broadcast or in forced-mono (for stereo broadcast).

STEREO

In **Stereo** broadcast.

DUAL A

If dual broadcast detected. **Dual A** is selected in default and also can be selected after **Dual B** by Remote Control.

DUAL B

If **Dual B** selected by Remote Control.



Muting the Sound

Press the “” (muting) button to turn off and on the sound. One of the sound marks below will appear on the upper left side of the screen.

The mark will also appear when the left or Right button pressed.

It is placed in the upper left side of the screen when enabled.

Sound Off   Sound On

When sound is off, pressing “ + “/” - ” buttons restores the previous volume level

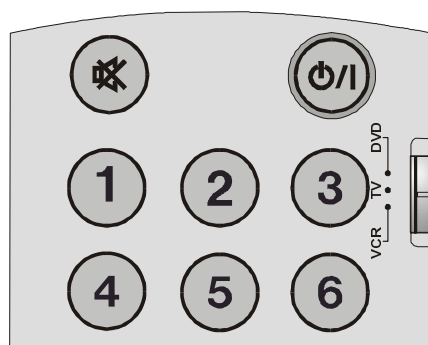

If **PIP layout** is selected, the sound mark is displayed at the upper middle of the PIP window.

Hyper Sound

By selecting Hyper Sound in sound menu or by pressing the “” button on your remote control, Pseudo/Spatial effect can be turned on or off. In Mono transmission the left and right channels will be added at left channel and dummy stereo effect will introduced to end-user.

In stereo transmission it yields a phase dif-

ference between left and right channels. Hyper Sound selection will be displayed on the screen when the TV Status button is pressed or programme is changed.

EXT Modes

By pressing the “AV” button or via **source select** menu, you can switch your TV to EXT modes (except being in Teletext). Pressing this button will consecutively switch the TV in one of the optional EXT modes: **Tuner, Scart 1, Scart 1 RGB, Scart 2, Scart 2 RGB, PC, FAV** and **SVideo**.

While watching VCR; **vcr** item in **options** menu should be set to **on**.

Zoom Modes

Zoom mode bar is displayed when RED button(ZOOM) is pressed. You can change the screen size according to the picture aspect ratio. Select the optimum one from the following **ZOOM** modes.

AUTO:

When a **WSS (Wide Screen Signalling)** signal, which shows the aspect ratio of the picture, is included in the broadcast signal or the signal from an external device, the TV automatically changes the **ZOOM** mode to **16:9 ZOOM** mode **PANORAMIC** or **FULL** mode according to the **WSS** signal.

- When the **AUTO** mode does not function correctly due to poor **WSS** signal quality or when you want to change the **ZOOM** mode, change to another **ZOOM** mode manually.

Using the different screen formats

Press the “◀” or “▶” button to select the different modes: Auto, Full, 16:9 Zoom, 16:9 Zoom Subtitle, Regular, Panoramic, 14:9 Zoom modes.

FULL:

This uniformly stretches the left and right sides of a normal picture (4:3 aspect ratio) to fill the wide TV screen.

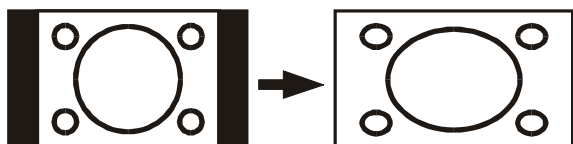

- For 16:9 aspect ratio pictures that have been squeezed into a normal picture (4:3 aspect ratio), use the **FULL** mode to restore the picture to its original shape.

16:9 ZOOM:

This zooms up the wide picture (16:9 aspect ratio) to the full screen.

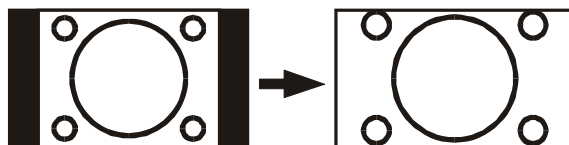

16:9 ZOOM SUBTITLE:

This zooms up the wide picture (16:9 aspect ratio) with subtitles to the full screen.

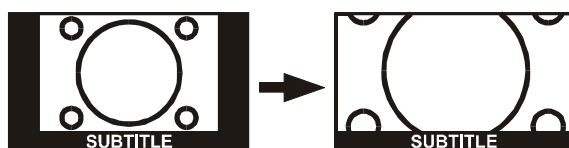

REGULAR:

Use to view a normal picture (4:3 aspect ratio) as this is its original shape.



PANORAMIC:

This stretches the left and right sides of a normal picture (4:3 aspect ratio) to fill the screen, without making the picture appear unnatural.

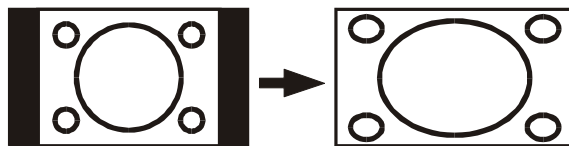

The top and bottom of the picture are slightly cut off.

14:9 ZOOM:

This zooms up the wide picture (14:9 aspect ratio) to the upper and lower limits of the screen.

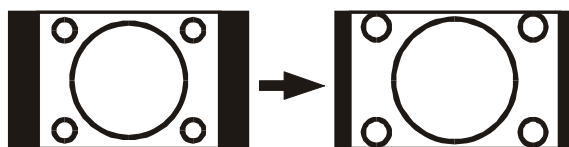

Teletext

Teletext is an information system that displays text on your TV screen. Using the Teletext information system you can view a page of information on a subject that is available in the list of contents (index).

The menu is not available in text mode.

Contrast, brightness or colour control is not available, but volume control is available in text mode.

To Operate Teletext

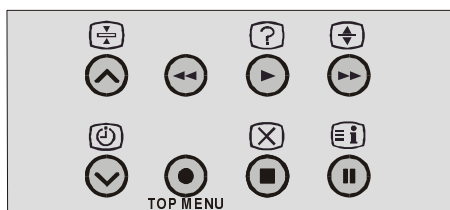

- Select a TV station on which Teletext is being transmitted.
- Press “” button. Usually the list of contents (index) is displayed on the screen.



To Select a Page Of Teletext

- Press the appropriate digit buttons for the required Teletext page number.

The selected page number is displayed at the top left corner of the screen. The Teletext page counter searches until the selected page number is located, so that the desired page is displayed on the screen.



- Press “**P**” button to move the Teletext screen forward one page at a time.
- Press “**P**” button to move the Teletext screen backward one page at a time.

To Select Index Page



- To select the page number of the index (generally page 100), press “” button.

Searching for a teletext page while watching TV



- In the Teletext mode pressing “” button will switch the screen to the TV mode. In the TV mode enter a page number using digit buttons. As you enter last digit of page num-

ber, “” sign will replace the page number and flash until the entered page number is found. Then the page number will replace “” sign again. Now you can display this teletext page pressing “” button

To Select Double Height Text



- Press “” button for the top half of the information page to be displayed in double height text.
- Press “” button again for the bottom half of the information page to be displayed in double height text.
- Press “” button once more for the full page of normal height text.

To Reveal “Concealed” Information

- Pressing “” button once will reveal answers on a quiz or games page.
- Pressing “” button again will conceal the revealed answers.



To Stop Automatic Page Change

The teletext page you have selected may contain more information than what is on the screen; the rest of the information will be displayed after a period of time.

- Press “” button to stop the automatic page change.
- Press “” button again to allow the next page to be displayed.

To Select A Subcode Page

Subcode pages are subsections of long Teletext pages that can only be displayed on the screen one section at a time.

- Select the required Teletext page.
- Press “” button.
- Select the required subcode page number by pressing four digit buttons (e.g. 0001).
- If the selected subcode page is not displayed in a short time, press “” button. TV programme will be displayed on the screen.



- Teletext page number will be displayed on the upper left corner of the screen when the selected page is found.
- Press “” button to display the selected Teletext page.

To Exit Teletext

- Press “” button. The screen will switch to TV mode.

Fastext

Your TV supports the 10 page Teletext system. When the page number of any of the 10 pages in memory is entered, the system will not search for the requested page; instead it will display the page automatically.

- Press “**P**” button to move the Teletext screen forward one page at a time.
- Press “**P**” button to move the Teletext screen backward one page at a time.

For Fastext

The subject-heading for the information may have a particular color.



- Press an appropriate **RED**, **GREEN**, **YELLOW** or **BLUE** button in order to reach the relevant page quickly.

For TOP text

TOP text mode of operation will be activated automatically according to the transmission.

- If TOP text transmission is present, color coded buttons will appear in status row.
- If TOP text transmission is not present, status row will not appear.

The subject-heading for information may be located in colored box.

In Top mode the “**P** or **P**” commands will request the next or previous page respectively. If TOP text transmission is not available, in case of operation of these commands, wraparound occurs. For example page 100 appears to be one greater than page 199.

Connect Peripheral Equipment

There is a wide range of audio and video equipment that can be connected to your TV.

The following connection diagrams show you where the different equipment should be connected at the back or right side of the TV.

Via The Euroconnector

TFT TV has 2 Euroconnector sockets. If you want to connect peripherals (e.g. video, decoder, etc.) which have Euroconnectors, to the TV, use **Scart 1** or **Scart 2** inputs.

If an external device is connected via Euroconnector sockets TV is switched to EXT mode automatically. If the signal is RGB, select RGB in the source select menu to view picture. If the external device is connected to **Scart 1**, choose **Scart 1 RGB**. If the external device is connected to **Scart 2**, choose **Scart 2 RGB**.

Via Ant Input

If you want to connect to your TV, peripherals like video recorders or decoders, but the device you want to connect does not have Euroconnector, you should connect it to the ANT input of the TV.

If the VCR is connected via antenna input it is suggested to use the Programme 0.

Decoder

Cable TV offers you a wide choice of programs. Most of them are free, others are to be paid for by the viewer. This means that you will need to subscribe to the broadcasting organisation whose programmes you wish to receive. This organisation will supply you a corresponding decoder unit to allow the programmes to be unscrambled.

For further information ask your dealer. See also the booklet supplied with your decoder.

Connect a decoder with an aerial socket to the TV

- Connect the aerial cable.

Connect a decoder without an aerial socket to the TV

- Connect the decoder to the TV with a eurocable to **Scart 1**.

TV And Video Recorder

- Connect the aerial cables.

Better picture quality can be obtained if you also connect a eurocable to **SCART** sockets.

Playback NTSC

To use this option you can;

- Connect NTSC VCR player to Euroconnector at the rear side of the TV.
- Connect NTSC VCR player to RCA Jacks at the right side of the TV.

Then, press “**AV**” button to select proper source.

Copy Facility

Source selection for **VCR** recording.

- Select **options** menu.
- Select **scart 2 out** source pressing “▲” / “▼” button.
- Select **Scart 1** to copy the picture from tuner.
- Select **Scart 2** to copy the picture from **Tuner, FAV** or **Scart 1**.

Search For And Store The Test Signal Of The Video Recorder

- Unplug the aerial cable from the aerial socket “**ANT**” of your video recorder.
- Switch on your TV and put the video recorder on the test signal. (See the booklet for your video recorder.)
- Enter the **tv tuner** menu in **settings** menu. Enter the **programming** menu in **tv tuner** menu and select **manual search**.
- Search for the test signal of your video recorder in the same way as you searched for and stored the TV signals. See **programming** menu. Store the test signal under programme number 0.
- Replace the aerial cable in the aerial socket “**ANT**” of your video recorder once you have stored the test signal.

Camera And Camcorder to Connect to FAV Input

Connect your camera or camcorder FAV input at the right side of the TV.

- Connect your equipment to the TV via **VIDEO** (yellow), **AUDIO R** (red) and **AUDIO L** (white) inputs. You should connect the jacks to the input in the same color.

To Connect to SVideo Input

Connect your camera or camcorder SVideo input at the right side of the TV.

- Connect your equipment to the TV via SVideo input and audio inputs of FAV inputs by using SVideo cables.

Connect The Decoder To The Video Recorder

Some video recorders have a special euro-connector for decoder.

- Connect a eurocable to the euroconnector of your decoder and to the special euroconnector of your video recorder. See also the booklet of your video recorder.
- To connect your video recorder to the TV, see TV and Video Recorder section.

If you want to connect more equipment to your TV, consult your dealer.

Connecting Headphones

Use the stereo headphone socket at the right side of the TV, to connect headphones.

You can adjust the headphones volume and sound mode from the audio menu. See [page 14](#) for details.

Antenna Connections

Outdoor Antenna Connections

VHF antenna
Method 1

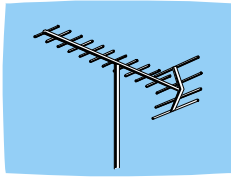

Round 75 ohm coaxial cable

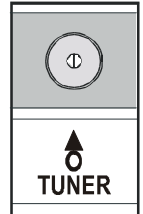

Rear of TV

VHF/UHF antenna
Method 2

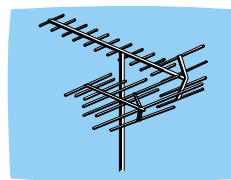

Flat 300-ohm twin lead cable

Round 75-ohm coaxial cable

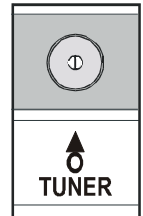

Rear of TV

Connect Peripheral Equipment

HEADPHONE



AUDIO

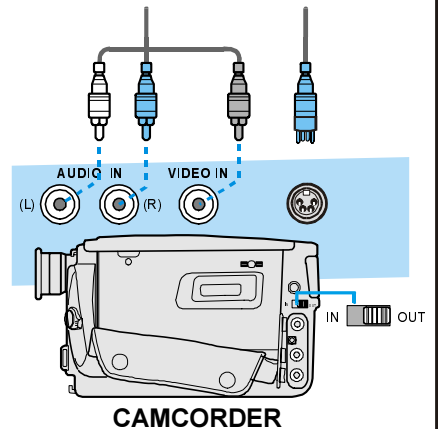
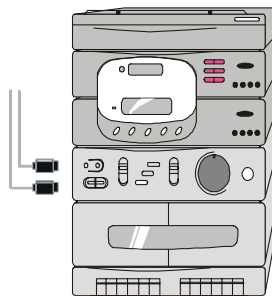

CAMCORDER

VIDEO

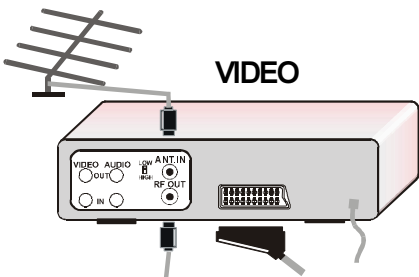

DECODER

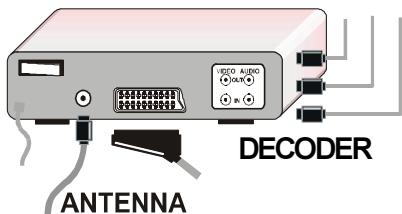

ANTENNA

FOR SATELLITE RECEIVER

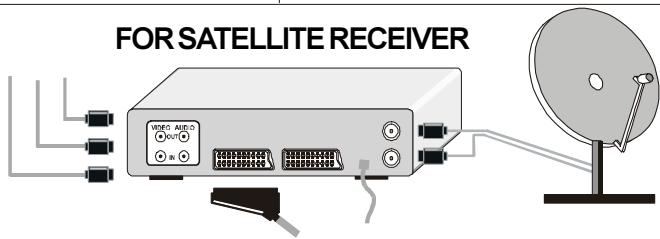

PC Input Typical Display Modes

The display has a maximum resolution of 1280 x 768, vertical sync. frequency range of 50-75 Hz and a horizontal sync. frequency range of 30-69 KHz.

The following table is an illustration of some of the typical video display modes.

Mode	Resolution		Frequency	
	Horizontal	Vertical	Hor. (kHz)	Ver. (Hz)
1	640	400	31.5	60
2	640	480	37.9	72
3	640	480	37.5	75
4	720	400	31.5	70
5	800	600	37.9	60
6	800	600	48.1	72
7	800	600	46.9	75
8	1024	768	48.4	60
9	1024	768	56.5	70
10	1024	768	60.0	75
11	1280	768	47,6	60

The native resolution of the TFT-LCD Panel is 1024 x 768. Therefore using Mode 10 is advised to get the best PC input display quality.

PIP Combination Restrictions

Main \ PIP	TUNER	SCART 1	SCART 2	SCART 1 RGB	SCART 2 RGB	FAV	PC	S-VIDEO
TUNER								
SCART 1								
SCART 2								
SCART 1 RGB								
SCART 2 RGB								
FAV								
PC								
S-VIDEO								

 This condition is not possible

Tips

Care Of The Screen

Clean the screen with a slightly damp, soft cloth. Do not use abrasive solvents as they may damage the TV screen coating layer.

Poor Picture

Have you selected the correct TV system? Is your TV set or house aerial located too close to the loudspeakers, non-earthed audio equipment or neon lights, etc.?

Mountains or high buildings can cause double pictures or ghost images. Sometimes you can improve the picture quality by changing the direction of the aerial.

Is the picture or Teletext unrecognisable? Check if you have entered the correct frequency.

The picture quality may degrade when two peripherals are connected to the TV at the same time. In such a case, disconnect one of the peripherals.

No Picture

Is the aerial connected properly? Are the plugs connected tightly to the aerial socket? Is the aerial cable damaged? Are suitable plugs used to connect the aerial? If you are in doubt, consult your dealer.

No Picture means that your TV is not receiving any transmission. Have you pressed the correct buttons on the remote control? Try once more.

PC Picture

If no PC picture appears, check the D-SUB cable is connected properly. Check that your PC's resolution set correctly. See [page 25](#) for supported modes.

Sound

You can not hear any sound. Did you perhaps interrupt the sound, pressing "X" button? Are external speakers connected to the TV?

Sound is coming from only one of the speakers. Is the balance set to one direction extreme? See **audio** menu.

Remote Control

Your TV no longer responds to the remote control. Perhaps the batteries are exhausted. Replace the batteries.

Have you selected the wrong menu? Press "**BACK**" button to return to TV mode or press "**MENU**" button to return to the previous menu.

No solution

Switch your TV set off and on. If this does not work, call the service personnel; never attempt to repair it yourself.

Specifications

Item	Model	LT-30E45SU
Broadcasting Systems		PAL SECAM, B/G, D/K, I/I', L/L'
Channels and Frequencies		VHF (VL) 46,25 MHz - 168,25 MHz VHF (VH) 175,25 MHz - 463,25 MHz UHF 471,25 MHz - 863,25 MHz Cable TV (S1-S20/S21-S41)
Input Signal		Video: Analog 0,7 Vp-p 75 ohm positive Sync: TTL Level positive or negative, Seperate sync.
Horizontal Timing		30 - 69 KHz
Vertical Timing		50 - 75 KHz
Dot Rate		78,75 MHz max.
Panel Size		29,5" (measured diagonally)
Visible Picture Size		643 mm horizontal x 386 mm vertical
Display Resolution		1280 x 768 max. (WXGA)
Number of Preset Channels		100
Channel Indicator		On Screen Display (OSD)
RF Aerial Output		75 Ohm (unbalanced)
Power Requirements		220-240 V AC, 50 Hz
Power Consumption (W)		150 W (max) / STAND-BY <4W
Sound Systems		German , Nicam Stereo
Audio Output		2 x 8 W _{RMS} (%10 THD)
EXT-1 Terminal		Euroconnector (21-pin, SCART 1) (bottom of the cabinet) • Video Input, Audio L/R Inputs and RGB inputs are available. • TV broadcast outputs (Video and Audio L/R) are available.
EXT-2 Terminal		Euroconnector (21-pin, SCART 2) (bottom of the cabinet) • Video Input, S-VIDEO (Y/C) input, Audio L/R and RGB inputs are available. • Video and Audio L/R outputs are available. • T-V LINK functions are available.
EXT-3 Terminal		RCA connectors x 3 (side of the cabinet) S-VIDEO connector x 1 (side of the cabinet) • Video input, S-VIDEO (Y/C) input and Audio L/R inputs are available.
Audio Output		RCA connectors x 2 (bottom of the cabinet) • Audio L-R Line Outs are available
PC IN terminal		Analog RGB D-SUB 15 x 1 • PC signal is available (refer to page 25 for details of the signals which can be input)
PC AUDIO IN terminal		Stereo mini-jack (3.5 mm diameter)
Dimensions (W x H x D)		847 mm x 522 mm x 260 mm 847 mm x 490 mm x 102 mm (TV only)
Weight		14.8 kg (with stand) / 13 kg (TV only)
Accessories		Remote control unit x 1 (RM-C1860) / AA/R6 dry cell battery x 2 Power cord x 1
Headphone jack		Stereo mini-jack (3.5 mm diameter)